

PALAZZETTI

IL CALORE CHE PIACE ALLA NATURA

IT UTILIZZO E FUNZIONALITÀ

EN USE AND FUNCTION

DE VERWENDUNG UND BETRIEB

FR UTILISATION ET FONCTIONNEMENT

ES USO Y FUNCIONES

STUFE A PELLETT - PELLETT STOVES
PELLETOFEN - POÊLES À GRANULÉS - PELLETT ESTUFA



EASY TOUCH



*Il presente manuale è parte integrante del prodotto.
Si raccomanda di leggere attentamente le istruzioni prima
dell'installazione, manutenzione o utilizzo del prodotto.*

*This manual is an integral part of the product.
Read the instructions carefully before installing, servicing or
operating the product.*

*Die vorliegende Anleitung ist fester Bestandteil des Produkts.
Vor der Installation, Wartung und Verwendung die Anleitungen
stets aufmerksam durchlesen.*

*Le présent manuel fait partie intégrante du produit.
Il est conseillé de lire attentivement les consignes
avant l'installation, l'entretien ou l'utilisation du produit.*

*Este manual es parte integrante del producto.
Se recomienda leer detenidamente las instrucciones antes
de la instalación, el mantenimiento y el uso del producto..*

IT

Gentile cliente,
desideriamo innanzitutto ringraziarLa per la preferenza che ha voluto accordarci acquistando il nostro prodotto e ci congratuliamo con Lei per la scelta.

Per consentirLe di utilizzare al meglio la Sua nuova stufa, la invitiamo a seguire attentamente quanto descritto nel presente manuale.

GB

Dear Customer,
We'd like to thank you for having purchased one of our products and congratulate you on your choice.

To make sure you get the most out of your new stove, please carefully follow the instructions provided in this manual.

DE

Sehr geehrter Kunde,
Zuallererst möchten wir Ihnen für den uns gewährten Vorzug danken und Ihnen zur Wahl gratulieren.

Damit Sie Ihren neuen Heizofen so gut wie möglich benutzen können, bitten wir Sie, die in dieser Bedienungs- und Wartungsanleitung enthaltenen Angaben genau zu befolgen.

F

Cher client,
Nous souhaitons avant tout vous remercier de la préférence que vous nous avez accordée en achetant notre produit et vous félicitons pour votre choix.

Afin de vous permettre de profiter au mieux de votre nouveau poêle, nous vous invitons à suivre attentivement les instructions reportées dans cette notice.

ES

Estimado Cliente,
Deseamos agradecerle por la preferencia que nos ha otorgado adquiriendo nuestro producto y lo felicitamos por su elección.

Para el mejor uso de su nueva estufa, lo invitamos a leer con atención cuanto se describe en el presente manual.

INDICE

1 CONFIGURAZIONE INIZIALE

- 1.1 ALLACCIAMENTO AD UN TERMOSTATO ESTERNO
- 1.2 REGOLAZIONE DEI DUE VENTILATORI POSTERIORI

2 PANNELLO COMANDI

- 2.1 DESCRIZIONE
- 2.2 USO DEL PANNELLO COMANDI
- 2.3 PARAMETRI DI FUNZIONAMENTO

3 OPERAZIONI PRELIMINARI

- 3.1 CARICAMENTO PELLET
- 3.2 ALIMENTAZIONE ELETTRICA
- 3.3 IMPOSTAZIONI INIZIALI

4 UTILIZZO DELLA STUFA

- 4.1 ACCENSIONE
- 4.2 MODIFICA DEI PARAMETRI
- 4.3 SPEGNIMENTO
- 4.4 FUNZIONAMENTO CON TERMOSTATO AMBIENTE
- 4.5 FUNZIONAMENTO CON SONDA AMBIENTE A BORDO STUFA

5 FUNZIONI DISPONIBILI

- 5.1 TIMER
- 5.2 FUNZIONE RISPARMIO "ECO MODE"
- 5.3 FUNZIONE DELTA DI RIACCENSIONE
- 5.4 RIACCENSIONE DOPO IL BLACK-OUT
- 5.5 FUNZIONE "BLOCCO TASTIERA"
- 5.6 FUNZIONE ANTIGELO

6 GESTIONE DEGLI ALLARMI

1 CONFIGURAZIONE INIZIALE

In funzione della tipologia di installazione è necessario impostare la stufa secondo la configurazione più corretta per il suo funzionamento.

Prima di procedere è necessario dare tensione alla stufa attraverso l'interruttore di sicurezza posto sul retro:

- a) Agendo sui tasti freccia ◀ ▶ portarsi sul menu setup ⚙ e premere il tasto ⏪;
- b) Selezionare la password "7" con il tasto + e confermare con il tasto ⏪;
- c) Scorrere con i tasti + - e selezionare il sottomenu [30]; lampeggerà "r--0";
- d) Premere il tasto ⏪ ed inserire il valore "54" con i tasti + -;
- e) Premere il tasto ⏪ per confermare;
- f) Verrà visualizzata la configurazione attualmente in uso;
- g) Se si vuole modificare, premere il tasto ⏪ ed inserire il valore della nuova configurazione con i tasti + -;
- h) Premere il tasto ⏪ per confermare.

! **Dopo aver modificato la configurazione potrebbe apparire un messaggio di errore di comunicazione per qualche secondo. Ignorarlo e spegnere la stufa dall'interruttore di sicurezza posto sul retro, attendere qualche secondo e riaccenderla.**

E' POSSIBILE IMPOSTARE DUE DIVERSE CONFIGURAZIONI:

CONFIGURAZIONE 1 (default)

Impostare tale configurazione per accendere e spegnere la stufa manualmente o in modo programmato.

La stufa modulerà la potenza in funzione della temperatura ambiente letta dalla sonda a bordo.

E' possibile impostare la funzione "Eco-mode" per far sì che la stufa si spenga o si riaccenda in base alla temperatura ambiente impostata.

In questa configurazione è possibile impostare anche la funzione antigelo.

CONFIGURAZIONE 2

Impostare tale configurazione quando la stufa viene comandata da un termostato (o cronotermostato) esterno.

In questa configurazione la stufa si spegne quando il termostato esterno è soddisfatto.

In questa configurazione non è possibile impostare anche la funzione antigelo.

1.1 ALLACCIAMENTO AD UN TERMOSTATO ESTERNO

È possibile collegare alla stufa un termostato o cronotermostato esterno che accenda e spenga la stufa.

Quando la temperatura è soddisfatta il termostato apre il circuito quindi spegne la stufa.

Il termostato esterno deve essere collegato ai morsetti 1 e 2 del connettore posto sul posteriore della stufa e che di fabbrica sono collegati alla sonda esterna. Scollegare, quindi, la sonda esterna e collegare al suo posto i due contatti del termostato.

E' importante impostare la stufa nella **configurazione 2** seguendo le istruzioni riportate nel paragrafo "Configurazione iniziale".

! • La prima volta, dopo l'installazione del cronotermostato, la stufa deve essere accesa manualmente, mentre il cronotermostato è nello stato di "chiamata". Tale operazione si rende necessaria anche nell'eventualità che ci sia una interruzione di alimentazione elettrica o qualora la stufa venga spenta manualmente.

! • Onde evitare sovrapposizioni di fasce orarie di funzionamento, si consiglia di disattivare (impostare su OFF) il timer della stufa.

Prima di procedere con la lettura del manuale, prendere visione della descrizione della stufa contenuta nel relativo manuale allegato.

1.2 REGOLAZIONE DEI DUE VENTILATORI POSTERIORI

All'atto dell'installazione è possibile regolare la portata dei due ventilatori posteriori in funzione della tipologia di impianto di distribuzione realizzato (lunghezza, sezione, materiali usati...). Una volta messa in funzione la stufa, e accesi i due ventilatori posteriori dal menu della ventilazione, regolare i due ventilatori posteriori agendo sui potenziometri posti sul retro della stufa (fig. 1.1-D), finché non si raggiunge il livello di ventilazione desiderato.

1.2.1 Collegare i ventilatori posteriori ad un termostato esterno

E' possibile collegare due termostati esterni alla morsettiera della stufa così da poter accendere e spegnere i ventilatori posteriori in funzione della temperatura impostata sui termostati.

Per poter sfruttare questa funzionalità è necessario che la ventilazione dei due ventilatori posteriori sia impostata su ON.

Il termostato che comanda il ventilatore Sinistro andrà collegato ai morsetti 3 e 4 della morsettiera.

Il termostato che comanda il ventilatore Destro andrà collegato ai morsetti 5 e 6 della morsettiera.

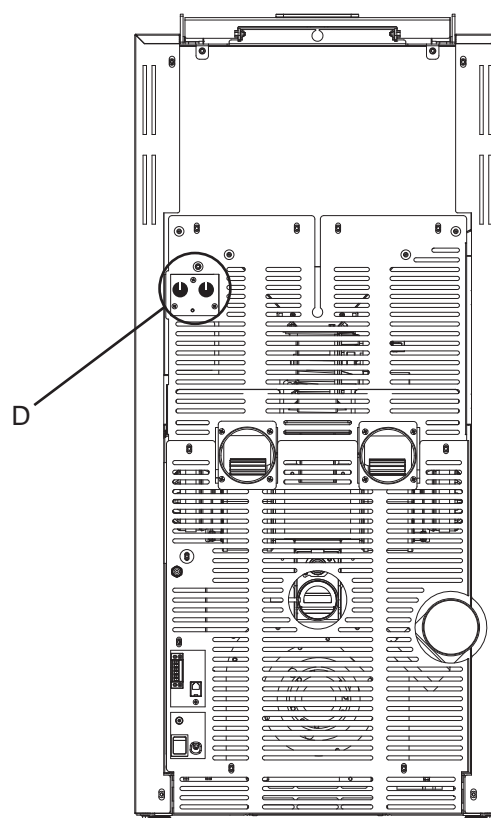









fig. 1.1

2 PANNELLO COMANDI

Prima di procedere con la lettura del manuale, prendere visione della descrizione della stufa contenuta nel relativo manuale allegato.

2.1 DESCRIZIONE

Il pannello comandi è composto da:

- A) una parte superiore con i led di stato e le icone retroilluminate che identificano ciascuna funzione;
- B) display a led;
- C) tasto di accensione ;
- D) tasto "Annulla" e visualizzazione "errore" ;
- E) due tasti freccia per spostarsi tra le varie funzioni  ;
- F) due tasti  e  per modificare i parametri di funzionamento e accedere ai sottomenu;
- G) un tasto di invio  per la conferma del parametro o della selezione















 *Tutti i tasti sono di tipo capacitivo, pertanto non necessitano di una pressione per essere attivati, ma è sufficiente sfiorarne la superficie.*

fig. 2.1

2.1.1 Led di stato

ICONA	AVVISO	DESCRIZIONE
	Pellet in esaurimento	Indica che è necessario ricaricare il serbatoio di pellet
	Manutenzione	Indica la necessità di effettuare una manutenzione
	Assistenza	Indica la presenza di un errore
	Ricevitore del telecomando	Riceve i comandi dal telecomando (opzionale).
	Timer attivo	Indica se è attiva la funzione timer.
	Led di segnalazione stato (vicino al tasto )	Led sempre acceso: stufa accesa e in lavoro Led intermittente: stufa in fase di accensione o in stand-by Led spento: stufa spenta









2.1.2 Descrizione dei menu

ICONA	FUNZIONE	DESCRIZIONE	VALORI
	Potenza	Impostazione della potenza di funzionamento	1..5
	Ventilazione	Impostazione della velocità dei ventilatori dell'aria ambiente.	c: OFF, 1..5; A; Hi r: ON/OFF L: ON/OFF
	Temperatura	Visualizza la temperatura letta in ambiente e permette di impostare la temperatura desiderata.	6°C .. 51°C
	Combustibile	Funzione non utilizzata	
	Timer	Abilita o disabilita il Timer. Quando è abilitato verrà visualizzata l'icona fissa 	ON - OFF

ICONA	FUNZIONE	SOTTOMENU	DESCRIZIONE	VALORI	
	Setup	{1}	Timer settimanale	Assegnazione dei programmi (max 3) ai vari giorni della settimana	[d1] ... [d7]
		{2}	Programmi	Menu di impostazione dei programmi	[P1] ... [P6]
		{3}	Orologio / data	Impostazione orologio e data	
		{4}	Ore Residue	Visualizza le ore mancanti alla manutenzione consigliata. Con il valore "Hi" si indica un numero superiore alle 999 ore.	
		{5}	Informazioni di sistema	Visualizza la versione software corrente	
		{6}	Funzione non abilitata		
		{7}	Funzione Eco	Abilita o meno l'Eco Mode che comporta lo spegnimento e la riaccensione automatica in funzione della temperatura ambiente (solo in configurazione 1).	OFF; Eco
		{8}	Delta di riaccensione	Differenza di gradi, rispetto alla temperatura di spegnimento al di sotto della quale la stufa si riaccende (solo in configurazione 1).	0,5 ... 5,0°C
		{9}	Temperatura antigelo	Temperatura minima al di sotto della quale la stufa si accende (solo in configurazione 1).	OFF; 3 ... 20 °C
		{10}	Blocco tastiera	Imposta la modalità di blocco dei tasti	OFF; Lo; Hi
		{11}	Luminosità display	Imposta il grado di luminosità del display	OFF; 1 ... 5
		{12}	Modalità display	Imposta la modalità di visualizzazione dei dati	OFF; 1 ... 4
		{13}	Volume cicalino	Imposta il volume dell'avviso acustico	OFF; 1 ... 5
		{14}	Combustione	È possibile impostare 3 diverse configurazioni di combustione	1 ... 3
		{15}	Funzione non abilitata		
{30}	Menu Installatore	Modifica/Visualizza la configurazione della stufa	PWD: "54"		
{40}	Menu di servizio	Menu di competenza del centro di assistenza			

I sottomenu {30} e {40} del menu Setup sono protetti da password e sono ad uso esclusivo del centro di assistenza tecnico.

2.2 USO DEL PANNELLO COMANDI

- Agendo sui tasti freccia   ci si sposta tra i diversi menu che si illuminano di volta in volta.
- Soffermendosi su una determinata funzione basta agire sul tasto  e modificarne i valori, con i tasti  .
- Una ulteriore pressione del tasto  conferma la modifica.
- In generale tutti i valori lampeggianti sono in quel momento modificabili con i tasti  .
- Il tasto "annulla"  consente di annullare la modifica; la sua pressione prolungata permette di visualizzare sul display un eventuale codice di allarme o di errore.

2.3 PARAMETRI DI FUNZIONAMENTO

Il funzionamento della stufa è determinato dai parametri di Potenza, Ventilazione e Temperatura impostati dall'utente.

2.3.1 Modifica della potenza

La potenza definisce la quantità di calore prodotta dalla stufa e quindi incide direttamente anche sui consumi. Per modificare la potenza:

- a) Portarsi con i tasti ◀ ▶ sul menu potenza 🔥 e premere il tasto ↵ ;
- b) Lampeggerà il valore di potenza; modificarne il valore con i tasti + - (1 minimo, ..., 5 massimo)
- c) Premere il tasto ↵ per confermare i dati impostati.

2.3.2 Modifica della ventilazione

Per modificare il valore della ventilazione:

- a) Portarsi con i tasti ◀ ▶ sul menu ventilazione 🍃 e premere il tasto ↵ ;
- b) Usare i tasti + - per spostarsi tra il ventilatore centrale [c], il ventilatore destro [r] e il ventilatore sinistro [L];
- a) Premere il tasto ↵ per selezionare il ventilatore desiderato;
- b) Selezionando il ventilatore centrale [c]; modificarne il valore con i tasti + - :
 - "OFF" = esclude completamente la ventilazione e la stufa funzionerà solo a convezione naturale;
 - "1" minimo, ..., "5" massimo;
 - "A" = funzionamento automatico (la stufa imposterà la velocità in funzione della temperatura ambiente);
 - "Hi" = funzionamento ultraveloce (da utilizzare solo se c'è la necessità di riscaldare velocemente un ambiente);
- c) Premere il tasto ↵ per confermare i dati impostati.

Se vengono selezionati i ventilatori posteriori destro [r] o sinistro [L], è possibile esclusivamente impostare i valori di ON e OFF.

Nell'eventualità che il ventilatore centrale sia stato messo a OFF e almeno uno dei due ventilatori posteriori è su ON, il ventilatore centrale si porrà automaticamente sul valore di minimo.

2.3.3 Modifica della temperatura ambiente

Modificando tale valore si definisce la temperatura che si desidera raggiungere in ambiente, letta direttamente da una sonda posta sulla stufa.

Per modificare il valore della temperatura desiderata:

- a) Portarsi con i tasti ◀ ▶ sul menu temperatura 🌡️ e premere il tasto ↵ ;
- b) Lampeggerà il valore attuale; modificarlo con i tasti + - ;
- c) Premere il tasto ↵ per confermare il dato impostato.

3 OPERAZIONI PRELIMINARI

3.1 CARICAMENTO PELLETTI

La prima operazione da eseguire prima di accendere il prodotto è quella di riempire il serbatoio di combustibile (pellet) utilizzando preferibilmente una apposita paletta.

Non svuotare il sacco direttamente nel serbatoio per evitare di caricare della segatura o altri elementi estranei che potrebbero compromettere il buon funzionamento della stufa e per evitare di disperdere il pellet al di fuori del serbatoio.



Assicurarsi di richiudere bene il coperchio del serbatoio dopo aver effettuato l'operazione di caricamento del pellet. Un interruttore di sicurezza (solo per i modelli dove previsto) ne verifica la corretta chiusura (IS in fig. 3.1) e manda in allarme la stufa se il coperchio viene lasciato aperto per più di un minuto a stufa funzionante.

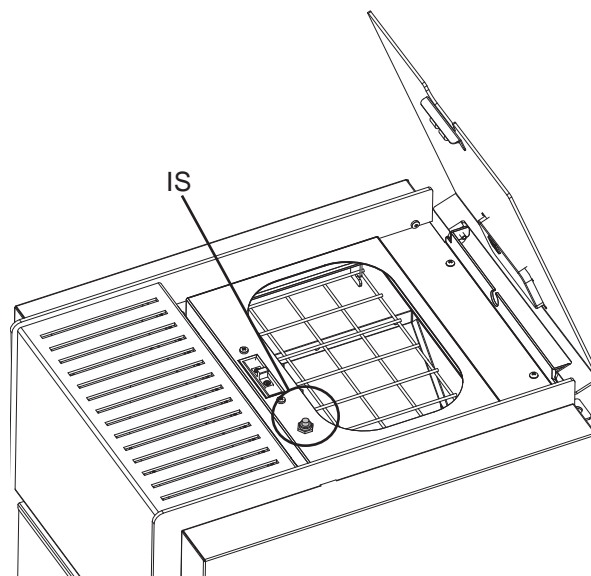

fig. 3.1

3.2 ALIMENTAZIONE ELETTRICA

Collegare la stufa alla rete elettrica, agire sull'interruttore di accensione posto sul retro della stufa posizionandolo su "I" (fig. 2.2). Se il collegamento è corretto la stufa emette una serie di segnali acustici intermittenti, si accende il display.



Per lunghi periodi di inutilizzo, si consiglia di posizionare l'interruttore sul retro della macchina in posizione di OFF (O).



Assicurarsi di non toccare il pannello di comando nel momento in cui viene data alimentazione alla stufa.

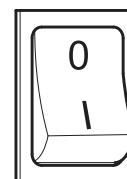

fig. 3.2

3.3 IMPOSTAZIONI INIZIALI

Prima di utilizzare la stufa è necessario impostare la data e l'ora corrente.

3.3.1 Impostazione orario e data

Per modificare la data:

- a) Portarsi con i tasti ◀ ▶ sul menu setup ⚙ e premere il tasto ←
- b) Selezionare la password "7" con il tasto + e confermare con il tasto ←;
- c) Scorrere con il tasto +, selezionare il sottomenu [3] e confermare con il tasto ←;
- d) Lampeggerà il valore dell'ora; modificarne il valore con i tasti + - e premere il tasto ▶;
- e) Lampeggerà il valore dei minuti; modificarne il valore con i tasti + - e premere il tasto ▶;
- f) Lampeggerà il valore del giorno; modificarne il valore con i tasti + - e premere il tasto ▶;
- g) Lampeggerà il valore del mese; modificarne il valore con i tasti + - e premere il tasto ▶;
- h) Lampeggerà il valore dell'anno; modificarne il valore con i tasti + - e premere il tasto ▶;
- i) Lampeggerà il valore del giorno attuale della settimana (Lunedì = 1 ... Domenica = 7); modificarne il valore con i tasti + -;
- j) Premere il tasto ← per confermare i dati impostati.

3.3.2 Impostazione luminosità display

E' possibile impostare il grado di attenuazione della luminosità del display quando è nella modalità standby.

- Agendo sui tasti freccia ◀ ▶ portarsi sul menu setup ⚙️ e premere il tasto ⏪;
- Selezionare la password "7" con il tasto + e confermare con il tasto ⏪;
- Scorrere con il tasto + e selezionare il sottomenu [11] e confermare con il tasto ⏪;
- Impostare con i tasti + e - il valore di luminosità desiderato (OFF, 1 ... 5) e confermare con il tasto ⏪.

3.3.3 Impostazione modalità display

E' possibile impostare cosa si vorrà visualizzare sul display quando quest'ultimo è nella modalità standby

- Agendo sui tasti freccia ◀ ▶ portarsi sul menu setup ⚙️ e premere il tasto ⏪;
- Selezionare la password "7" con il tasto + e confermare con il tasto ⏪;
- Scorrere con il tasto + e selezionare il sottomenu [12] e confermare con il tasto ⏪;
- Impostare con i tasti + e - uno dei seguenti valori:
 - "0FF" • Il display resterà fisso sull'ultima visualizzazione operata dall'utente;
 - "1" • Verranno visualizzati ciclicamente tutti i parametri di funzionamento;
 - "2" • Viene visualizzata la temperatura (letta dalla sonda ambiente)
 - "3" • Viene visualizzata l'ora corrente
 - "4" • Viene visualizzata l'autonomia in ore prima di dover ricaricare il serbatoio, se la funzione rifornimento è stata abilitata.
- Premere il tasto ⏪ per confermare i dati impostati.

3.3.4 Impostazione volume

E' possibile impostare il livello di volume del cicalino, in base alle proprie necessità:

- Agendo sui tasti freccia ◀ ▶ portarsi sul menu setup ⚙️ e premere il tasto ⏪;
- Selezionare la password "7" con il tasto + e confermare con il tasto ⏪;
- Scorrere con il tasto + e selezionare il sottomenu [13] e confermare con il tasto ⏪;
- Impostare con i tasti + e - il livello di volume desiderato (OFF, 1 ... 5) e confermare con il tasto ⏪.

3.3.5 Ottimizzazione della combustione

Una combustione ottimale dipende da diversi fattori (tipo di installazione, condizioni di funzionamento e di manutenzione, tipologia di pellet ecc..)

In linea di massima, se a fine combustione, nel braciere restano molti residui, è consigliabile modificare le configurazioni di combustione (aumentandone il valore) fino a trovare la soluzione più soddisfacente.

- Agendo sui tasti freccia ◀ ▶ portarsi sul menu setup ⚙️ e premere il tasto ⏪;
- Selezionare la password "7" con il tasto + e confermare con il tasto ⏪;
- Scorrere con il tasto + e selezionare il sottomenu [14] e confermare con il tasto ⏪;
- Impostare con i tasti + e - uno dei seguenti valori:
 - "1"
 - "2"
 - "3"
- Premere il tasto ⏪ per confermare i dati impostati.

4 UTILIZZO DELLA STUFA

4.1 ACCENSIONE

 Prima di ogni accensione, accertarsi che il braciere sia completamente vuoto e correttamente posizionato nella sua sede.

Per accendere la stufa tenere premuto il tasto  per qualche secondo.

L'icona a forma di fiamma inizierà a lampeggiare, durante la fase di accensione fino a restare fissa a stufa accesa.

 Accensione automatica: la stufa è dotata di un dispositivo automatico che consente l'accensione del pellet senza l'utilizzo di altri accenditori tradizionali.

 Evitare di accendere manualmente la stufa se il sistema di accensione automatico è compromesso.

 Durante la prima accensione della stufa si possono generare sgradevoli odori o fumi causati dall'evaporazione o dall'essiccamento di alcuni materiali utilizzati. Tale fenomeno andrà via via a scomparire.

Si consiglia, durante le prime accensioni, di mantenere i locali ben arieggiati.

STUFE DELLA SERIE "ERMETICA":

Ogni qual volta si apre la porta del focolare evitare di lasciarla aperta per un lungo periodo onde evitare che il sensore di chiusura notifichi lo stato di porta aperta, attraverso un allarme acustico.

4.2 MODIFICA DEI PARAMETRI

E' possibile modificare i parametri di funzionamento della stufa secondo quanto già riportato.

 I valori impostati verranno mantenuti fino alla successiva variazione, anche a stufa spenta o scollegata dall'alimentazione elettrica.

4.3 SPEGNIMENTO

Per spegnere la stufa tenere premuto il tasto  per qualche secondo; l'icona a forma di fiamma si spegnerà.

 Per effettuare una nuova accensione si consiglia di attendere che la stufa si sia completamente raffreddata.

 Si raccomanda di spegnere la stufa seguendo scrupolosamente quanto sopra riportato ed evitare assolutamente di farlo togliendo l'alimentazione elettrica.

4.4 FUNZIONAMENTO CON TERMOSTATO AMBIENTE

Quando la stufa viene comandata da un termostato (o cronotermostato) esterno, l'installatore deve aver impostato la configurazione 2. In questo caso **la stufa si spegne** quando il termostato esterno è soddisfatto (circuitto aperto).

La stufa si riaccende automaticamente quando la temperatura scende al di sotto del valore impostato sul termostato esterno (circuitto chiuso).

 **Alla prima accensione, o qualora lo spegnimento sia avvenuto direttamente dalla stufa (tasto )**, si dovrà procedere ad accendere la stufa direttamente dal pannello comandi.

4.5 FUNZIONAMENTO CON SONDA AMBIENTE A BORDO STUFA

La stufa può essere accesa/spenta manualmente o in modo programmato.

La stufa modula la potenza in funzione della temperatura ambiente letta dalla sonda a bordo (cioè la stufa tenta di mantenere la temperatura desiderata consumando il meno possibile).

Nell'eventualità l'utente abbia abilitato la funzione "Eco-mode", la stufa invece di modulare, si spegne al raggiungimento della temperatura impostata, e si riaccende quando la temperatura ambiente scende al di sotto del delta impostato.

E' possibile impostare la temperatura desiderata in ambiente nel menu temperatura .

5 FUNZIONI DISPONIBILI

5.1 TIMER

E' possibile impostare, abilitare ed assegnare ai vari giorni della settimana, i programmi personalizzati per l'accensione e/o lo spegnimento automatico della stufa.



























E' possibile configurare fino a sei programmi personalizzati.

Per ciascun programma si può impostare: ora di accensione, ora di spegnimento e temperatura desiderata.

A ciascun giorno della settimana è possibile assegnare fino a tre programmi.





















I giorni della settimana sono identificati da numeri: Lunedì = "d1", Martedì = "d2";...; Domenica = "d7".

5.1.1 Impostazione programmi







- Agendo sui tasti freccia   portarsi sul menu setup  e premere il tasto .
- Selezionare la password "7" con il tasto  e confermare con il tasto .
- Selezionare il sottomenu  e confermare con il tasto .
- Scorrere con i tasti  e  i programmi Pl...P6; selezionare con il tasto  quello che si vuole modificare;
- Lampeggerà il valore dell'ora di accensione; modificarne il valore con i tasti  e  e premere il tasto .
- Lampeggerà il valore dei minuti; modificarne il valore con i tasti  e  e premere il tasto .
- Lampeggerà il valore dell'ora di spegnimento; modificarne il valore con i tasti  e  e premere il tasto .
- Lampeggerà il valore dei minuti; modificarne il valore con i tasti  e  e premere il tasto .
- Lampeggerà il valore della temperatura desiderata; modificarne il valore con i tasti  e .
- Premere il tasto  per confermare i dati impostati.

5.1.2 Assegnare i programmi ai giorni

Con questa funzione è possibile assegnare fino a tre programmi diversi ad un determinato giorno.

- Agendo sui tasti freccia   portarsi sul menu setup  e premere il tasto .
- Selezionare la password "7" con il tasto  e confermare con il tasto .
- Selezionare il sottomenu  e confermare con il tasto .
- Scegliere con i tasti  e  il giorno [d1]...[d7] al quale si vogliono associare i programmi;
- Selezionarlo con il tasto .
- Lampeggerà il valore del primo programma da assegnare: Pl...P6 oppure "OFF" per disabilitarlo;
- Modificarne il valore con i tasti  e  e premere il tasto .
- Lampeggerà il valore del secondo programma da assegnare: Pl...P6 oppure "OFF" per disabilitarlo;
- Modificarne il valore con i tasti  e  e premere il tasto .
- Lampeggerà il valore del terzo programma da assegnare: Pl...P6 oppure "OFF" per disabilitarlo;
- Modificarne il valore con i tasti  e  e premere il tasto  per confermare i dati impostati.

5.1.3 Abilitazione/disabilitazione timer

- Agendo sui tasti freccia   portarsi sul menu Timer .
- Confermare con il tasto .
- Scorrere con i tasti  e  e selezionare: "ON" per abilitare il timer oppure "OFF" per disabilitarlo.
- Premere il tasto  per confermare la selezione.













Quando il timer è abilitato apparirà l'icona fissa  ad indicare che il timer è attivo.

5.2 FUNZIONE RISPARMIO “ECO MODE”

Abilitando questa funzione si fa in modo che la stufa, al raggiungimento della temperatura desiderata in ambiente, si spenga. Se tale funzione non è abilitata, la stufa modula il proprio funzionamento per mantenere la temperatura desiderata consumando il meno possibile.

La funzione “Eco Mode” è disponibile solo nella configurazione 1.











Per abilitare/disabilitare tale funzione:

- Agendo sui tasti freccia   portarsi sul menu setup  e premere il tasto .
- Selezionare la password “7” con il tasto  e confermare con il tasto .
- Selezionare il sottomenu  e confermare con il tasto .
- Impostare con i tasti  e  uno dei seguenti valori:
 -  → Abilita la funzione “Eco Mode”
 -  → Disabilita la funzione “Eco Mode”
- Premere il tasto  per confermare i dati impostati.

5.3 FUNZIONE DELTA DI RIACCENSIONE

Il Delta di riaccensione è il numero di gradi al di sotto della temperatura di spegnimento oltre il quale la stufa si riaccende automaticamente. Ad esempio se la stufa è impostata per spegnersi a 20°C (Eco Mode attivo) e impostiamo un “Delta di riaccensione” di 4°C, la stufa si riaccenderà quando rileva una temperatura inferiore o uguale a 16°C.

Per modificare il valore del delta di riaccensione:

- Agendo sui tasti freccia   portarsi sul menu setup  e premere il tasto .
- Selezionare la password “7” con il tasto  e confermare con il tasto .
- Selezionare il sottomenu  e confermare con il tasto .
- Lampeggerà il valore; modificarlo con i tasti  e  (0,5 ... 5,0°C);
- Premere il tasto  per confermare il dato impostato.













5.4 RIACCENSIONE DOPO IL BLACK-OUT

In caso di interruzione di corrente elettrica, la stufa si riaccenderà automaticamente, verificando le condizioni di sicurezza, al ritorno dell'alimentazione.

5.5 FUNZIONE “BLOCCO TASTIERA”

Con questa funzione è possibile bloccare l'utilizzo del pannello comandi per evitare modifiche accidentali.











Per abilitare/disabilitare tale funzione:

- Agendo sui tasti freccia   portarsi sul menu setup  e premere il tasto .
- Selezionare la password “7” con il tasto  e confermare con il tasto .
- Selezionare il sottomenu  e confermare con il tasto .
- Impostare con i tasti  e  uno dei seguenti valori:
 - “OFF” → Blocco tastiera disattivato
 - “Lo” → Resta abilitato solo il tasto di accensione/spegnimento 
 - “Hi” → Blocco tastiera attivato
- Premere il tasto  per confermare i dati impostati.

5.6 FUNZIONE ANTIGELO



(solo in configurazione 1)

E' possibile impostare una temperatura minima al di sotto della quale la stufa si accende (al di fuori delle fasce orarie impostate, e solo se il timer è attivo). Per modificare il valore della temperatura di “antigelo”:















- Agendo sui tasti freccia   portarsi sul menu setup  e premere il tasto .
- Selezionare la password “7” con il tasto  e confermare con il tasto .
- Selezionare il sottomenu  e confermare con il tasto .
- Lampeggerà il valore; modificarlo con i tasti  e  (OFF; 3...20°C);
- Premere il tasto  per confermare il dato impostato.

6 GESTIONE DEGLI ALLARMI

Nel caso si verifichi un'anomalia nel funzionamento, viene attivata la seguente procedura:

- 1) allarme acustico (beep);
- 2) si illumina uno dei seguenti led di sistema:   ;
- 3) se l'anomalia riguarda un errore, la stufa si spegnerà.

La pressione prolungata del tasto "annulla"  consente la visualizzazione sul display del codice di errore:

CODICE ERRORE/AVVISO	DESCRIZIONE	POSSIBILI CAUSE	LED
E001	Pannello comandi difettoso	Difettosità del pannello comandi	
E002	Errore di comunicazione segnale telecomando	Difettosità del pannello comandi	
E004	Errore di comunicazione	Cavo di collegamento tra scheda e pannello comandi interrotto o staccato. Se appare durante il cambio di configurazione, ignorare tale errore	
E101	Errore di mancata accensione	Mancanza di pellet Qualità del pellet Sistema di accensione guasto Braciere sporco	
E105	Allarme sonda pellet	Sonda pellet scollegata o difettosa	
E108*	Errore di sicurezza	Portina o sportello di caricamento aperti	
E109	Errore di pressione o sicurezza termica	Sistema di evacuazione fumi sporco Guarnizioni di tenuta logorate Aria comburente insufficiente Problemi di surriscaldamento del serbatoio pellet	
E110	Malfunzionamento sonda di temperatura	Sonda aria difettosa	
E111	Malfunzionamento sonda fumi	Sonda temperatura fumi difettosa	
R001	Livello pellet basso. (icona lampeggiante)	Pellet in esaurimento	
R002	Avviso di manutenzione programmata. (icone lampeggianti)	Periodicamente la stufa richiede che venga effettuata una manutenzione da parte di un tecnico specializzato	 
R007	Malfunzionamento sensore di pressione. (icona lampeggiante)	Sensore di pressione o scheda guasti.	
----	Pulizia stufa	Camera di combustione, braciere o sistema di evacuazione dei fumi sporchi. Tubi rilevamento pressione staccati o ostruiti. Ingresso dell'aria comburente ostruito.	
----	Errore di mancata accensione	Pellet esaurito; Resistenza di accensione guasta; Guarnizioni consumate; Posizione del braciere non corretta	

* Solo per i modelli provvisti di microinterruttori di sicurezza sulla portina o sul coperchio del serbatoio.

Dopo aver verificato il tipo messaggio è possibile resettare l'allarme premendo per qualche istante il tasto di accensione/spegnimento .

Nell'eventualità che il codice d'errore sia "E109", prima di resettare l'allarme, riattivare il termostato a riarmo manuale posto sul retro della stufa (Fig. 6.1) (a cura del Centro di Assistenza Tecnico).



Prima di procedere con una nuova accensione verificare che:

- la stufa si sia raffreddata
- il braciere sia pulito e sgombro da qualsiasi residuo di cenere o pellet
- il braciere sia correttamente posizionato nella sua sede
- le porte del focolare e del serbatoio siano perfettamente chiuse.



fig. 6.1

INDEX

1 INITIAL CONFIGURATION

- 1.1 CONNECTION TO AN EXTERNAL TIMER THERMOSTAT
- 1.2 ADJUSTING REAR FANS

2 CONTROL PANEL

- 2.1 DESCRIPTION
- 2.2 USING THE CONTROL PANEL
- 2.3 OPERATING PARAMETERS

3 PRELIMINARY OPERATIONS

- 3.1 LOADING THE PELLETS
- 3.2 POWER SUPPLY
- 3.3 INITIAL SETTINGS

4 STOVE OPERATION

- 4.1 STARTING THE STOVE
- 4.2 MODIFYING THE PARAMETERS
- 4.3 SWITCHING OFF
- 4.4 OPERATION WITH ROOM THERMOSTAT
- 4.5 OPERATION WITH ROOM PROBE ON THE STOVE

5 FUNCTIONS AVAILABLE

- 5.1 TIMER
- 5.2 "ECO MODE" SAVING FUNCTION
- 5.3 RESTART DELTA FUNCTION
- 5.4 RESTARTING AFTER A POWER FAILURE
- 5.5 "LOCK KEYPAD" FUNCTION
- 5.6 FROST PROTECTION FUNCTION

6 ALARM MANAGEMENT

1 INITIAL CONFIGURATION

Depending on the type of installation, the best configuration needs to be selected for the stove operation. Before proceeding, power up the stove using the safety switch on the rear.

- a) Use the arrow buttons ◀ ▶ to go to the setup menu ⚙ and then press ↵;
- b) Use the + button to select the password "7" and then press ↵ to confirm;
- c) Use the + - buttons to scroll to and select submenu [30]; "r--0" will flash on the display;
- d) Press ↵ and enter the value "54" using the + - buttons;
- e) Press ↵ to confirm;
- f) The current configuration will be displayed;
- g) To change the configuration, press ↵ and enter the value of the new configuration using the + - buttons;
- h) Press ↵ to confirm.

! **After having changed the configuration a communication error message may be displayed for a few seconds. Ignore this and switch the stove off using the safety switch on the rear, wait a few seconds and switch it back on.**

TWO DIFFERENT CONFIGURATIONS ARE AVAILABLE:

CONFIGURATION 1 (default)

Set this configuration to switch the stove on or off manually or in programmed mode.

The stove will module its power according to the room temperature read by the probe on the stove.

It is possible to set the function "Eco-mode" to allow the stove switch on or off according to the set temperature.

In this configuration it is possible to set also the antifreeze function.

CONFIGURATION 2

Set this configuration when the stove is controlled by an external thermostat (or timer thermostat).

In this configuration the stove switches off when reaching the external thermostat setting.

In this configuration it is not possible to set also the antifreeze function.

1.1 CONNECTION TO AN EXTERNAL TIMER THERMOSTAT

The stove can be connected to an external timer thermostat that switches the stove on or off according to the set temperature.

The external thermostat must be connected to terminals 1 and 2 of the connector on the back of the heater which are connected to the external probe at the factory. So disconnect the external probe and connect the two contacts of the thermostat in its place.

The stove must be set to configuration 2 following the instructions shown in the paragraph on "Initial configuration".

! **After first installing the timer thermostat, the stove needs to be switched on manually, while the timer thermostat is in "call" status. This operation is also required in the event of power failures or if the stove is switched off manually.**

! **To avoid overlapping the working time bands, it's recommend to disable (set to OFF) the stove's timer.**

1.2 ADJUSTING REAR FANS

At installation time you can adjust the flow rate of the rear fans according to the type of distribution system created (length, cross section, materials used ...).

Once you start up the heater and switch on rear fans from the ventilation menu, adjust rear fans by acting on the potentiometers on the back of the stove (see Figure 1.1-D) until you reach the desired level of ventilation.

1.2.1 Connecting the rear fans to an external thermostat

It is possible to connect two external thermostats to the terminal block of the heater so as to be able to switch on and off the rear fans according to the temperature set on the thermostats.

To take advantage of this feature, the ventilation of the two rear fans should be set to ON.

The thermostat which controls the Left fan should be connected to terminals 3 and 4 of the terminal block.

The thermostat which controls the Right fan should be connected to terminals 5 and 6 of the terminal block.

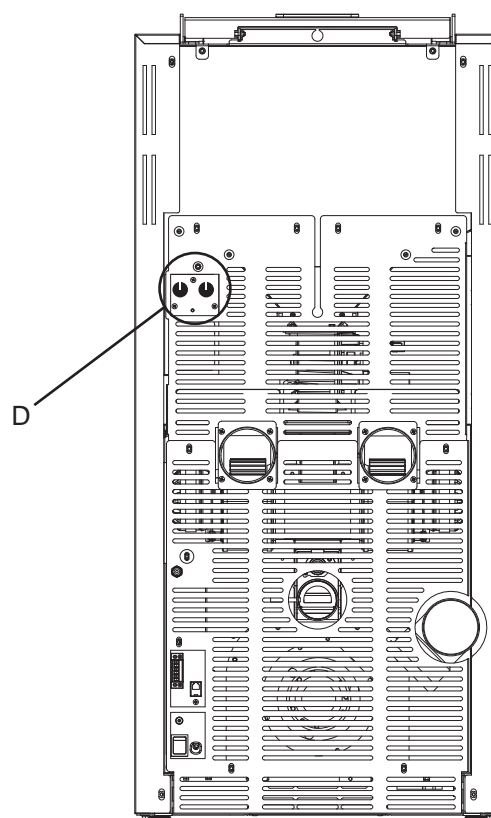

fig. 1.1

2 CONTROL PANEL

Before reading the manual, review the description of the stove given in the enclosed manual.

2.1 DESCRIPTION

The control panel consists of:

- A) a top part with status LEDs and backlit icons that identify each function;
- B) LED display;
- C) ON button (⏻);
- D) "Cancel" and display "error" button (↩);
- E) two arrow buttons to scroll between the various functions (⏪ ⏩);
- F) two buttons (+) and (-) to set the operating parameters and access the submenus;
- G) an enter button (↵) to confirm the parameter or the settings.















 All the buttons are capacitive, therefore the functions are activated without needing to press hard on the buttons, rather by just touching the surface.

fig. 2.1

2.1.1 Status leds

ICON	WARNING	DESCRIPTION
	Pellets running out	Indicates that the pellet hopper needs to be refilled.
	Maintenance	Indicates the need to perform maintenance
	Service	Indicates an error
	Remote control receiver	It receives the inputs sent by the remote control (optional)
	Timer active	Indicates whether the timer function is active.
	Status LED (near the ⏻ button)	LED on steady: stove on and operating LED flashing: stove in the ignition stage or in standby LED off: stove off









2.1.2 Description of the menus

ICON	FUNCTION	DESCRIPTION	VALUES
	Power	Stove output setting	1..5
	Fan	It allows you to set the fan speed.	c: OFF,1..5; A; Hi r: ON/OFF L: ON/OFF
	Temperature	Displays the room temperature reading and is used to set the desired temperature.	6°C .. 51°C
	Fuel	Not used	
	Timer	Enables or disables the timer. When enabled, the icon  will be displayed steady (not flashing)	ON - OFF

ICON	FUNCTION	SUBMENU	DESCRIPTION	VALUES
	Setup	[1] Weekly timer	Assigns the programs (max 3) to the different days of the week	[d1] ... [d7]
		[2] Programs	Program setting menu	[P1] ... [P6]
		[3] Time / date	Time and date setting	
		[4] Hours remaining	Displays the number of hours remaining until recommended maintenance. When "Hi" is displayed, the remaining time exceeds 999 hours.	
		[5] System information	Displays the current software version	
		[6] Function not enabled		
		[7] Eco function	Enables or disables Eco Mode, in which the stove automatically switches off and on based on room temperature (only in configuration 1).	OFF; Eco
		[8] Restart delta	Difference in degrees from room temperature below which the stove switches on again (only in configuration 1).	0,5 ... 5,0°C
		[9] Frost protection temperature	Minimum temperature below which the stove switches on (only in configuration 1).	OFF; 3 ... 20 °C
		[10] Lock keypad	Disables the buttons on the keypad	OFF; Lo; Hi
		[11] Display brightness	Sets display brightness	OFF; 1 ... 5
		[12] Display mode	Sets how the data is displayed	OFF; 1 ... 4
		[13] Buzzer volume	Sets the buzzer volume	OFF; 1 ... 5
		[14] Combustion	Three different types of combustion can be set	1 ... 3
		[15] Function not enabled		
		[30] Installer menu	Sets/displays the stove configuration	PWD: "54"
[40] Service menu	Menu reserved for the service centre			

Submenus [30] and [40] in the Setup menu are password-protected and reserved for service centre personnel.

2.2 USING THE CONTROL PANEL

- The arrow buttons   are used to scroll between the different menus that are highlighted.
- When selecting a given function, simply press the  button and then modify the values, again using the   buttons.
- Pressing the  button confirms the setting.
- In general all values that are flashing can be modified using the   buttons.
- The "cancel" button  is used to cancel any changes; pressing and holding the button displays any active alarm or error codes.

2.3 OPERATING PARAMETERS

Stove operation is determined by the Power level, Fan and Temperature parameters set by the user.

2.3.1 setting the power level

The power level defines the amount of heat produced by the stove and consequently directly affects fuel consumption.

To change the power level:

- a) Use the ◀ ▶ buttons to go to the power menu 🔥 and press ↵ ;
- b) The power level value will flash; set the value using the + - (buttons (1 minimum,...5 maximum)
- c) Press ↵ to confirm the settings.

2.3.2 Modifying the fan speed

To modify the fan speed:

- a) Use the ◀ ▶ keys to move through the ventilation menu 🌀 and press the ↵ key;
- b) Use the + - keys to move between the central fan [c], the right fan [r] and the left fan [L];
- a) Press the ↵ key to select the fan required;
- b) Selecting the central fan [c], change its value with the + - keys:
 - "OFF" = excludes ventilation completely and the heater will only work by natural convection;
 - "1" minimum ... "5" maximum;
 - "A" = automatic operation (the heater will set the speed according to the ambient temperature);
 - "Hi" = ultra-fast operation (to be used only if there is a need to heat an environment quickly);
- c) Press the ↵ key to confirm the settings.

If the right [r] or left [L] rear fans are selected, you can only set the values of ON and OFF.

In the event that the central fan was set to OFF and at least one of the two rear fans is ON, the central fan will automatically set itself to the minimum setting.

2.3.3 Setting the room temperature

Setting this value defines the desired room temperature, read directly by a probe fitted on the stove.

To set the desired temperature:

- a) Use the ◀ ▶ buttons to go to the temperature menu 🌡️ and press ↵ ;
- b) The current value will flash; change it using the + - buttons
- c) Press ↵ to confirm the settings.

3 PRELIMINARY OPERATIONS

3.1 LOADING THE PELLETS

The first operation to be performed before starting the appliance is to fill the hopper with fuel (pellets).

The pellets are loaded into in the hopper using a scoop.

Do not empty the sack directly into the hopper so as to avoid loading sawdust or other foreign bodies that may affect proper stove operation and avoid spilling pellets outside of the hopper.



Make sure the hopper lid is well closed again after having loaded the pellets. A safety switch (just for the models that are equipped with it) makes sure that the pellet tank lid has been closed properly (IS in fig. 3.1) and triggers a stove alarm in case the pellet tank lid stays open for more than one minute while the stove is still working.

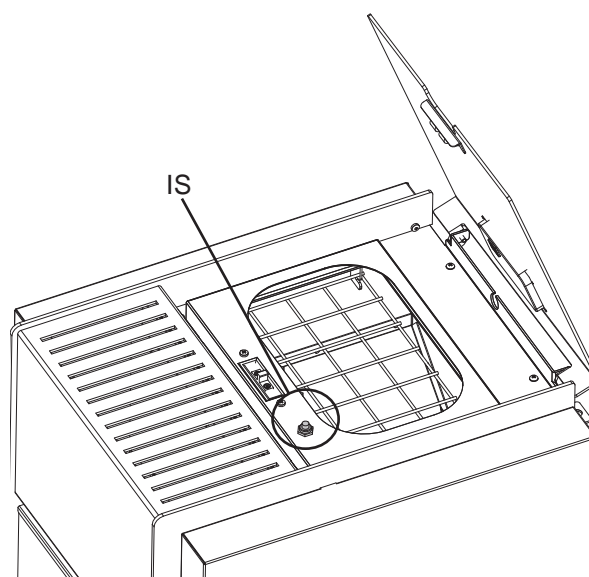

fig. 3.1

3.2 POWER SUPPLY

Plug the stove into the mains power supply, move the power switch at the rear of the stove to position "I" (Fig. 3.2). If the connections are correct the stove will emit a series of intermittent beeps, the display will come on.



Make sure not to touch the control panel while plugging the stove into the power supply.



If not using the appliance for an extended period, the switch at the rear of the stove should be moved to position (O).

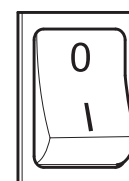

fig. 3.2

3.3 INITIAL SETTINGS

The language, current date and time need to be set before using the stove.

3.3.1 Time and Date setting

To set the date:

- a) Use the ◀ ▶ buttons to go to the setup menu ⚙ and press ⏪;
- b) Use the + button to select the password "7" and then press ⏪ to confirm;
- c) Use the + button to scroll to and select submenu [3] and press ⏪ to confirm;
- d) The hour value will flash; set the value using the + - buttons and press ▶;
- e) The minutes value will flash; set the value using the + - buttons and press ▶;
- f) The day value will flash; set the value using the + - buttons and press ▶;
- g) The month value will flash; set the value using the + - buttons and press ▶;
- h) The year value will flash; set the value using the + - buttons and press ▶;
- i) The current weekday value will flash (Monday = 1... Sunday = 7); set the value using the + - buttons;
- j) Press ⏪ to confirm the settings.

3.3.2 Setting the display brightness

Display brightness when in standby mode can be set.

- Use the arrow buttons (◀ ▶) to go to the setup menu  and then press (↵);
- Use the (+) button to select the password "7" and then press (↵) to confirm;
- Use the (+) button to scroll to and select submenu [11] and press (↵) to confirm;
- Set the desired brightness (OFF, 1 ... 5) using the (+) (-) buttons and press (↵) to confirm.

3.3.3 Setting the display mode

The data shown on the display when this is in standby mode can be set.

- Use the arrow buttons (◀ ▶) to go to the setup menu  and then press (↵);
- Use the (+) button to select the password "7" and then press (↵) to confirm;
- Use the (+) button to scroll to and select submenu [12] and press (↵) to confirm;
- Set one of the following values using the (+) and (-) buttons:
 - "OFF" • The display remains on the last operation set by the user;
 - "1" • All operating parameters are displayed cyclically;
 - "2" • The room probe temperature is shown
 - "3" • The current time is shown
 - "4" • The operating autonomy in hours before having to refill the hopper is shown, If the function "filling" has been activated.
- Press (↵) to confirm the settings.

3.3.4 Setting the volume

The volume of the buzzer can be set based on requirements:

- Use the arrow buttons (◀ ▶) to go to the setup menu  and then press (↵);
- Use the (+) button to select the password "7" and then press (↵) to confirm;
- Use the (+) button to scroll to and select submenu [13] and press (↵) to confirm;
- Set the desired volume (OFF, 1 to 5) using the (+) (-) buttons and press (↵) to confirm.

3.3.5 Improving the combustion

A good combustion depends on several factors (type of installation, operation and maintenance conditions, type of pellet etc ..)

If at the end of combustion in the brazier are many waste, it is advisable to change the combustion configurations (increasing the value) to find the most satisfactory solution.

- Use the arrow buttons (◀ ▶) to go to the setup menu  and then press (↵);
- Use the (+) button to select the password "7" and then press (↵) to confirm;
- Use the (+) button to scroll to and select submenu [14] and press (↵) to confirm;
- Set one of the following values using the (+) and (-) buttons:
 - "1"
 - "2"
 - "3"
- Press (↵) to confirm the settings.

4 STOVE OPERATION

4.1 STARTING THE STOVE



Before every ignition, be sure that burning pot is completely empty and properly positioned in its seat.

To start the stove hold the  button for several seconds.

The flame icon will start flashing during the ignition stage until remaining on steady when the stove has started.



Automatic stove ignition: the stove comes with an automatic device that starts the pellet stove without using other traditional fire lighters.



Avoid lighting the flame manually if the stove's automatic ignition system is not working correctly.



When the stove is started the first time, unpleasant odours or smoke may be generated, caused by evaporation or drying of certain materials used. This phenomenon will gradually disappear.

The room should be well ventilated when starting the stove the first few times.

“SEALED” SERIES STOVES

When opening the firebox door, never leave it open too long, otherwise the door sensor will set off the open door signal (audible alarm).

4.2 MODIFYING THE PARAMETERS

The stove operating parameters can be modified as described.



The values set will be retained until next modified, even when the stove is switched off or unplugged from the power supply.

4.3 SWITCHING OFF

To switch the stove off hold the  button for a few seconds; the flame icon will switch off.



To start the stove again it's recommended to wait for the stove to cool down completely.



The stove should only be switched off following the procedure described above. Never switch the stove off by unplugging it from the power supply.

4.4 OPERATION WITH ROOM THERMOSTAT

When the stove is controlled by an external thermostat (or timer thermostat) the installer must have set Configuration 2. In this configuration the stove switches off when reaching the external thermostat setting.

The stove switches on again automatically when the temperature falls below the value set on the external thermostat (circuit closed).



On first ignition, or if the stove has been switched off manually ( button), the stove needs to be started directly from the control panel.

4.5 OPERATION WITH ROOM PROBE ON THE STOVE

The stove can be switched on/off manually or in programmed mode.

The stove modulates output according to the room temperature read by the probe on the stove (that is, the stove attempts to maintain the desired temperature while minimising fuel consumption).

If the user has enabled the “Eco-mode” function, the stove rather than modulating its output, switches off when reaching the set temperature, and switches on again when the room temperature falls below the delta set.

The desired room temperature can be set in the temperature menu .

5 FUNCTIONS AVAILABLE

5.1 TIMER

It's possible to set, enable and assign to the various days of the week, customised programs for automatically switching the stove on and off.



























Up to six customised programs can be set.

For each program, the following can be set: on time, off time and desired temperature.

Up to three programs can be assigned for each day of the week.





















The days of the week are identified by numbers: Monday = "d1", Tuesday = "d2";...; Sunday = "d7" ..

5.1.1 Setting the programs







- Use the arrow buttons   to go to the setup menu  and then press .
- Use the  button to select the password "7" and then press  to confirm;
- Select submenu  and confirm by pressing .
- Use the   buttons to scroll the programs P1...P6;
- The on hours value will flash; set the value using the   buttons and press .
- The minutes value will flash; set the value using the   buttons and press .
- The off hours value will flash; set the value using the   buttons and press .
- The minutes value will flash; set the value using the   buttons and press .
- The desired temperature value will flash; set the value using the   buttons and press .
- Press  to confirm the settings.

5.1.2 Assigning the programs to specific days

This function can be used to assign up to three different programs to a certain day.

- Use the arrow buttons   to go to the setup menu  and then press .
- Use the  button to select the password "7" and then press  to confirm;
- Select submenu  and confirm by pressing .
- Use the   buttons to choose the day [d1]...[d7] to assign the programs to
- Select this using the  button;
- The value of the first program to assign will flash: P1...P6 or "OFF" to disable;
- Set the value using the   buttons and press .
- The value of the second program to assign will flash: P1...P6 or "OFF" to disable;
- Set the value using the   buttons and press .
- The value of the third program to assign will flash: P1...P6 or "OFF" to disable;
- Set the value using the   buttons and press  to confirm the settings.

5.1.3 Enabling/disabling the timer

- Use the arrow buttons   to go to the Timer menu .
- Select this using the  button;
- Use the   buttons to scroll and select: "ON" to enable the timer or "OFF" to disable it;
- Press  to confirm the selection.

When the timer is enabled, the  icon will be on steady, indicating that the timer is active.

5.2 “ECO MODE” SAVING FUNCTION

Enabling this function means that the stove switches off when reaching the desired room temperature. If this function is not enabled, the stove modulates operation so as to maintain the desired temperature while consuming the least amount of fuel possible. The “Eco Mode” function is only available in configuration 1.

To enable/disable the function:

- Use the arrow buttons to go to the setup menu and then press .
- Use the button to select the password “7” and then press to confirm;
- Select submenu [7] and confirm by pressing .
- Set one of the following values using the buttons:
 - ECC → “Eco Mode” function enabled
 - OFF → “Eco Mode” function disabled
- Press to confirm the settings.

5.3 RESTART DELTA FUNCTION

The Restart delta is the number of degrees centigrade below the switch-off temperature at which the stove switches on again automatically. For example, if the stove is set to switch off at 20°C (Eco Mode active) and “Restart delta” is set to 4°C, the stove will switch on again when the temperature measured is less than or equal to 16°C.

To set the restart delta value:

- Use the arrow buttons to go to the setup menu and then press .
- Use the button to select the password “7” and then press to confirm;
- Select submenu [8] and press to confirm;
- The value will flash; change it using the and buttons (0,5 ... 5,0°C);
- Press the button to confirm the set value.

5.4 RESTARTING AFTER A POWER FAILURE

In the event of power failures, the stove will switch back on automatically, checking the safety conditions, when power returns.

5.5 “LOCK KEYPAD” FUNCTION

This function is used to disable the use of the control panel and avoid accidental modifications.

To enable/disable the function:

- Use the arrow buttons to go to the setup menu and then press .
- Use the button to select the password “7” and then press to confirm;
- Select submenu [10] and confirm by pressing .
- Use the buttons to set one of the following values:
 - “OFF” Lock keypad disabled
 - “Lo” Only the on/off button is enabled
 - “Hi” Lock keypad enabled
- Press to confirm the settings.

5.6 FROST PROTECTION FUNCTION



(Only in configuration 1)

A minimum temperature can be set below which the stove will switch on (outside of the set time bands, and only if the timer is active). To set the “frost protection” temperature:

















- Use the arrow buttons to go to the setup menu and then press .
- Use the button to select the password “7” and then press to confirm;
- Select submenu [9] and confirm by pressing .
- The value will flash; change it using the buttons (OFF; 3...20°C);
- Press to confirm the settings.

6 ALARM MANAGEMENT

If a malfunction occurs, the following procedure is activated:

- 1) audible alarm (beep);
- 2) one of the following system LEDs come on:   ;
- 3) if the problem concerns an error, the stove will switch off.

Pressing and holding the “cancel” button  shows the error code on the display:

ERROR/ WARNING CODE	DESCRIPTION	POSSIBLE CAUSES	LED
E001	Faulty control panel	Control panel fault	
E002	Remote control signal communication error	Control panel fault	
E004	Communication error	Connection cable between board and control panel interrupted or detached. If this appears when changing configuration, ignore the error	
E101	Failed ignition error	No pellets Pellet quality Faulty ignition system Burn pot dirty Problems with the heating system Problems with the pump	
E105	Pellet probe malfunction	Pellet probe disconnected or faulty	
E108*	Safety error	Door or hopper lid open	
E109	Pressure error or thermal safety	Flue gas exhaust system dirty Seal gaskets worn Insufficient combustion air Problems with overheating in the pellet hopper	
E110	Temperature probe malfunction	Faulty air temperature probe	
E111	Flue gas temperature probe malfunction	Faulty flue gas temperature probe	
R001	Low pellet level (<i>icon flashing</i>)	Pellets running out	
R002	Scheduled maintenance warning (<i>icons flashing</i>)	The stove periodically requires maintenance to be performed by a qualified technician	  
R007	Pressure sensor malfunction (<i>icon flashing</i>)	Pressure sensor or board fault.	
----	Clean stove	Combustion chamber, burn pot or flue gas exhaust system dirty. Pressure measuring tubes detached or blocked. Combustion air intake blocked.	
----	Failed ignition error	No pellets; Faulty ignition heater; Worn gaskets; Incorrect burn pot position	

* Only for the models equipped with safety microswitches on the door or on the hopper lid.

After having checked the type of message, the alarm can be reset by pressing the on/off button  for a few moments.

If the error code is “E109”, before resetting the alarm, manually reset the thermostat located on the rear of the stove (Fig. 6.1) (*this should be carried out by an authorized technician*).



Before proceeding with a new ignition, check that:

- the stove has cooled
- the burning pot is clean and free of any ash residue or pellet
- the burning pot is correctly positioned in its seat
- the doors of the hearth and the tank are perfectly closed



fig. 6.1

INHALT

- 1 ANFÄNGLICHE KONFIGURATION**
 - 1.1 ANSCHLUSS AN EINEN SEPARATEN UHRENTHERMOSTAT
 - 1.2 EINSTELLUNG DER ZWEI HINTEREN VENTILATOREN

- 2 BEDIENFELD**
 - 2.1 BESCHREIBUNG
 - 2.2 BENUTZUNG DES BEDIENPANELS
 - 2.3 BETRIEBSPARAMETER

- 3 ERSTE SCHRITTE**
 - 3.1 PELLETZUFÜHRUNG
 - 3.2 STROMVERSORGUNG
 - 3.3 ANFÄNGLICHE EINSTELLUNGEN

- 4 GEBRAUCH DES OFENS**
 - 4.1 EINSCHALTEN
 - 4.2 BEARBEITEN DER PARAMETER
 - 4.3 AUSSCHALTEN
 - 4.4 BETRIEB MIT RAUMTHERMOSTAT
 - 4.5 BETRIEB MIT RAUMTEMPERATURFÜHLER AM OFEN

- 5 VERFÜGBARE FUNKTIONEN**
 - 5.1 TIMER
 - 5.2 SPARFUNKTION "ECO MODE"
 - 5.3 FUNKTION EINSCHALTDIFFERENZ
 - 5.4 WIEDEREINSCHALTEN NACH STROMAUSFALL
 - 5.5 FUNKTION „TASTATURSPERRE“
 - 5.6 FROSTSCHUTZFUNKTION

- 6 VERWALTUNG DER ALARMMELDUNGEN**

1 ANFÄNGLICHE KONFIGURATION

Je nach Installationsart muss der Ofen gemäß der für seinen Betrieb korrekten Konfiguration eingestellt werden. Bevor mit der Konfiguration zu beginnen, muss die Spannungszufuhr zum Ofen über den Sicherheitsschalter an der Rückseite eingeschaltet werden.

- a) Mit den Pfeiltasten ⏪ ⏩ das Menü Setup  aufrufen und die Taste ⏪ drücken;
- b) Mit der Taste + das Passwort "7" anwählen und mit der Taste ⏪ bestätigen;
- c) Mit den Tasten + - scrollen und das Untermenü [30] anwählen; es blinkt "r--□";
- d) Die Taste ⏪ drücken und mit den Tasten + - den Wert "54" eingeben;
- e) Zur Bestätigung die Taste ⏪ drücken;
- f) Es wird die aktuelle Konfiguration angezeigt;
- g) Um sie zu ändern, die Taste ⏪ drücken und mit den Tasten + - den Wert der neuen Konfiguration eingeben;
- h) Zur Bestätigung die Taste ⏪ drücken.

! **Nach Änderung der Konfiguration erscheint unter Umständen ein paar Sekunden lang eine Kommunikations-Fehlermeldung. Meldung ignorieren und den Ofen mit dem Sicherheitsschalter an der Rückseite aus- und nach ein paar Sekunden wieder einschalten.**

ES KÖNNEN ZWEI VERSCHIEDENE KONFIGURATIONEN EINGESTELLT WERDEN:

KONFIGURATION 1 (Voreinstellung)

Diese Konfiguration wird gewählt, um der Ofen von Hand oder programmiert ein-/auszuschalten.

Der Ofen regelt die Wärmeleistung anhand der Raum-Temperatur, die von der Sonde abgelesen wird.

Es ist möglich, die Funktion „Eco-Mode“ zu aktivieren, sodass der Ofen sich abschaltet bei Erreichen der Solltemperatur und erst dann wieder ein, wenn die Raumtemperatur erreichen muss.

In dieser Konfiguration ist es möglich, auch die Frostschutzfunktion zu wählen.

KONFIGURATION 2

Diese Konfiguration wird gewählt, wenn der Ofen von einem Raumthermostat (oder Uhrenthermostat) gesteuert wird.

In dieser Konfiguration wird der Ofen ausgeschaltet, sobald die Wärmeanforderung des Raumthermostats erfüllt ist.

In dieser Konfiguration ist es nicht möglich, die Frostschutzfunktion zu wählen.

1.1 ANSCHLUSS AN EINEN SEPARATEN UHRENTHERMOSTAT

An den Ofen kann ein separater Uhrenthermostat angeschlossen werden, mit dem er je nach eingestellter Temperatur ein- und ausgeschaltet wird.

Der innere Thermostat muss an die Klemmen 1 und 2 des Konnektors, der sich auf der Rückseite des Ofens befindet, angeschlossen werden. Die Klemmen sind werksmäßig an die äußere Sonde angeschlossen, daher muss die externe Sonde getrennt werden und stattdessen müssen die zwei Kontakte des Thermostates angeschlossen werden.

Der Ofen muss unbedingt auf **Konfiguration 2** eingestellt sein; hierzu die Anleitungen Im Abschnitt „Anfängliche Konfiguration“ befolgen.

! Für die erste Inbetriebnahme nach Installation des Uhrenthermostats muss der Ofen von Hand eingeschaltet werden, während der Uhrenthermostat auf den Status „Anfrage“ eingestellt ist. Dieser Vorgang ist auch dann erforderlich, wenn ein Stromausfall aufgetreten ist oder der Ofen von Hand ausgeschaltet wurde.

! Damit sich keine Betriebszeiten überschneiden, wird empfohlen, den Timer des Ofens zu deaktivieren (auf OFF einstellen).

1.2 EINSTELLUNG DER ZWEI HINTEREN VENTILATOREN

Im Zuge der Installation kann die Förderleistung der beiden hinteren Ventilatoren, je nach Art der installierten Verteileranlage (Länge, Querschnitt, verwendete Materialien usw.), eingestellt werden.

Sobald der Ofen in Betrieb genommen wurde und die beiden hinteren Ventilatoren mittels des Lüftungsmenüs eingeschaltet worden sind, müssen die beiden hinteren Ventilatoren mit Hilfe der Potentiometer, die sich auf der Rückseite des Ofens befinden (Abb. 1.1 -D-), auf das gewünschte Lüftungsniveau eingestellt werden.

1.2.1 Anschluss der hinteren Ventilatoren an ein externes Thermostat

Es können zwei externe Thermostate an das Klemmenbrett des Ofens angeschlossen werden. Dadurch können die hinteren Ventilatoren, je nach eingestellter Temperatur, an den Thermostaten ein- und ausgeschaltet werden.

Damit diese Funktion verwendet werden kann, müssen beide hinteren Ventilatoren auf ON gestellt sein.

Der Thermostat, der den LINKEN Ventilator steuert, muss an die Klemmen 3 und 4 des Klemmenbrettes angeschlossen werden.

Der Thermostat, der den RECHTEN Ventilator steuert, muss an die Klemmen 5 und 6 des Klemmenbrettes angeschlossen werden.

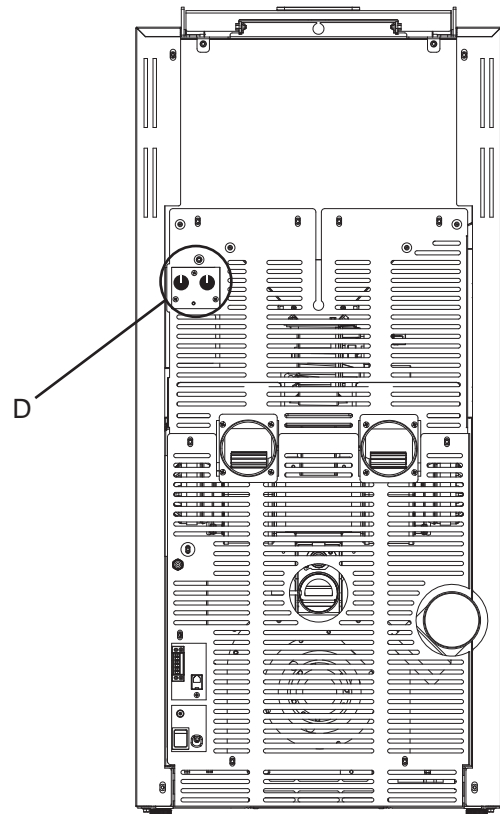

fig. 1.1

2 BEDIENFELD

Vor dem Lesen der Anleitung die Beschreibung des Heizofens zurate ziehen, die im beiliegenden Handbuch enthalten ist.

2.1 BESCHREIBUNG

Bestandteile des Bedienpanels:







- A) obere Anzeigeleiste mit den Status-LEDs und den hinterleuchteten Symbolen der einzelnen Funktionen;
- B) LED-Display;
- C) inschalttaste (⏻);
- D) Taste „Abbrechen“ und „Fehleranzeige“ (⏪);
- E) zwei Pfeiltasten für die Navigation durch die verschiedenen Funktionen (⏪ ⏩);
- F) zwei Tasten (+) und (-) zum Bearbeiten der Betriebsparameter und zum Aufrufen der Untermenüs;
- G) eine Eingabetaste (↵) für die Bestätigung des Parameters oder der Auswahl.









fig. 2.1

 *Alle Tasten sind kapazitiv, d.h. zur Aktivierung müssen sie nicht gedrückt, sondern lediglich berührt werden.*

2.1.1 Led di stato

SYMBOL	MELDUNG	BESCHREIBUNG
	Pellets fast leer	Der Pelletbehälter muss gefüllt werden.
	Wartung	Ein Wartungseingriff muss durchgeführt werden
	Service	Zeigt das Vorliegen eines Fehlers an
	Empfänger der Fernbedienung	Es nimmt die Befehle von dem Fernbedienung an (optional)
	Timer aktiv	Zeigt an, ob die Funktion Timer aktiv ist.
	Status-LED(vneben der Taste (⏻))	Led mit Dauerlicht: Ofen eingeschaltet und in Betrieb Led blinkt: Ofen in Einschaltphase oder Standby Led erloschen: Ofen ausgeschaltet

2.1.2 Menübeschreibung

SYMBOL	FUNKTION	BESCHREIBUNG	WERTE
	Leistung	Einstellung der Betriebsstufe	1..5
	Lüftung	Damit koennen Sie die Geschwindigkeit des Raumluftheblaeses einstellen	c: OFF,1..5; A; Hi r: ON/OFF L: ON/OFF
	Temperatur	Anzeige der im Raum abgelesenen Temperatur und Möglichkeit zur Einstellung der gewünschten Temperatur.	6°C .. 51°C
	Brennstoff	Diese Funktion wird nicht verwendet.	
	Timer	Timer aktivieren oder deaktivieren. Wenn er aktiviert ist, wird das Symbol dauerhaft angezeigt 	ON - OFF

SYMBOL	FUNKTION	UNTERMENÜ	BESCHREIBUNG	WERTE
	Setup	{1} Wochentimer	Zuweisung der Programme (max. 3) an die verschiedenen Wochentage	[d1] ... [d7]
		{2} Programme	Menü der Programmeinstellung	[P1] ... [P6]
		{3} Uhrzeit / Datum	Uhrzeit und Datum einstellen	
		{4} Verbleibende Stunden	Anzeige der verbleibenden Stunden bis zur empfohlenen Wartung. Mit dem Wert "Hi" wird eine Zahl über 999 Stunden angegeben.	
		{5} Systeminformationen	Anzeige der aktuellen Software-Version	
		{6} Funktion nicht aktiviert		
		{7} Funktion Eco	Schaltet den Modus Eco frei bzw. sperrt ihn, wodurch das Ausschalten und Wiedereinschalten anhand der Raumtemperatur automatisch erfolgt (nur in der Konfiguration 1).	OFF; Eco
		{8} Einschaltdifferenz	Differenzwert in Grad im Vergleich zur Raumtemperatur, bei deren Unterschreitung der Ofen wieder eingeschaltet wird (nur in der Konfiguration 1).	0,5 ... 5,0°C
		{9} Frostschutztemperatur	Mindesttemperatur, bei deren Unterschreitung der Ofen eingeschaltet wird (nur in der Konfiguration 1).	OFF; 3 ... 20°C
		{10} Tastatursperre	Modus Tastatursperre einstellen	OFF; Lo; Hi
		{11} Displayhelligkeit	Helligkeitsgrad des Displays einstellen	OFF; 1 ... 5
		{12} Displaymodus	Anzeigemodus der Daten einstellen	OFF; 1 ... 4
		{13} Summerlautstärke	Lautstärke des Signaltons einstellen	OFF; 1 ... 5
		{14} Verbrennung	Ändern der Verbrennungskonfigurationen	1 ... 3
		{15} Funktion nicht aktiviert		
{30} Installateur-Menü	Ofenkonfiguration bearbeiten/anzeigen	PWD: "54"		
{40} Service-Menü	Dem Kundendienst vorbehaltenes Menü			

Die Untermenüs {30} und {40} des Menüs Setup sind passwortgeschützt und sind ausschließlich dem Kundendienst vorbehalten.

2.2 BENUTZUNG DES BEDIENPANELS

- Mit den Pfeiltasten (◀) (▶) wird der Cursor zwischen den verschiedenen, jeweils aufleuchtenden Menüs bewegt.
- Innerhalb einer bestimmten Funktion einfach die Taste (↵) betätigen und mit den Tasten (+) (-) die Werte ändern.
- Mit der nochmaligen Betätigung der Taste (↵) wird die Änderung bestätigt.
- Im Allgemeinen können zu diesem Zeitpunkt alle blinkenden Werte mit den Tasten (+) (-) geändert werden.
- Mit der Taste "abbrechen" (⏏) kann die Änderung abgebrochen werden; durch anhaltendes Drücken dieser Taste wird ein eventueller Alarm- oder Fehlercode auf dem Display angezeigt.

2.3 BETRIEBSPARAMETER

Der Ofenbetrieb wird von den benutzerdefinierten Leistungs-, Lüftungs- und Temperaturparametern bestimmt.

2.3.1 Leistungsstufe ändern

Die Leistung definiert die vom Ofen erzeugte Wärmemenge und hat daher direkten Einfluss auf den Verbrauch. Zur Änderung der Leistung:

- Mit den Tasten ◀ ▶ das Menü Leistung 🔥 aufrufen und die Taste ↵ drücken;
- Der Leistungswert blinkt; den Wert mit den Tasten + - ändern (1 kleinste Stufe,...,5 Höchststufe).
- Die eingegebenen Daten mit der Taste ↵ bestätigen.

2.3.2 Lüftung ändern

Um die Lüftungsgeschwindigkeit zu ändern:

- Mit den ◀ ▶, Tasten das Lüftungsmenü 🌿 auswählen und mit der ↵ Taste bestätigen;
- Mittels der + - Tasten kann zwischen dem zentralen [c], rechten [r] und linken [L] Ventilator gescrollt werden;
- Die ↵ Taste drücken, um den gewünschten Ventilator auszuwählen;
- Bei Auswahl des zentralen Ventilators [c]; die Werte mittels der + - Tasten ändern:
 - „OFF“ = die Lüftung ist komplett ausgeschaltet und der Ofen funktioniert nur mit einer natürlichen Lüftung;
 - „1“ niedrigste Stufe ... „5“ höchste Stufe;
 - „A“ = Automatikbetrieb (der Ofen stellt die Geschwindigkeit je nach Raumtemperatur ein);
 - „Hi“ = Schnellheizfunktion (nur dann verwenden, wenn ein Raum schnell aufgeheizt werden soll);
- Die ↵ Taste drücken, um die eingestellten Daten zu bestätigen.

Wenn der hintere rechte [r] oder linke [L] Ventilator ausgewählt wurde, können ausschließlich die Werte ON und OFF eingestellt werden.

Sollte der zentrale Ventilator auf OFF gestellt sein, aber mindestens einer der beiden hinteren Ventilatoren auf ON eingestellt sein, so schaltet sich der zentrale Ventilator automatisch mit der Mindestgeschwindigkeit ein.

2.3.3 Änderung der Raumtemperatur

Durch Ändern dieses Wertes wird die Temperatur festgelegt, die im Raum erreicht werden soll, und die direkt von einem am Ofen eingebauten Temperaturfühler gemessen wird.

Zur Änderung der gewünschten Raumtemperatur:

- Mit den Tasten ◀ ▶ das Menü Temperatur 🔒 aufrufen und die Taste ↵ drücken;
- Der aktuelle Wert blinkt; Wert mit den Tasten + - ändern;
- Den eingegebenen Wert mit der Taste ↵ bestätigen.

3 ERSTE SCHRITTE

3.1 PELLETZUFÜHRUNG

Bevor das Gerät eingeschaltet wird, muss als erstes der Brennstoffbehälter (Pellets) gefüllt werden.

Schütten Sie die Pellets nicht direkt aus dem Sack in den Behälter, um nicht versehentlich Sägemehl oder andere Fremdkörper einzufüllen, die den einwandfreien Betrieb des Ofens beeinträchtigen könnten, und um keine Pellets außerhalb des Behälters zu verstreuen.

➔ Nach dem Einfüllen der Pellets muss die Abdeckung des Brennstoffbehälters wieder gut verschlossen werden.

Ein Sicherheitsschalter (nur bei den Modellen, die einen solchen vorsehen) prüft, ob sie korrekt verschlossen ist. (IS in Abb. 3.1) sollte die Pelletsbehälter Abdeckung für mehr als eine Minute geöffnet bleiben, und der Ofen noch in Betrieb sein, der Sicherheitsschalter wird ein Alarm-Signal zum Ofen senden.

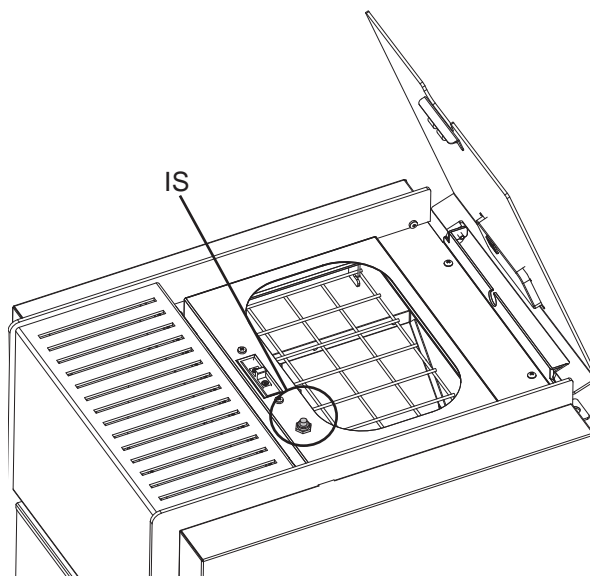

fig. 3.1

3.2 STROMVERSORGUNG

Den Ofen an das Stromnetz anschließen, den Einschalter an der Ofenrückseite antippen und auf „I“ stellen (Abb. 3,2). Wenn der Anschluss korrekt ist, gibt der Ofen mehrere aussetzende Signaltöne ab und das Display wird eingeschaltet.

! Bei längerem Stillstand wird empfohlen, den Schalter an der Ofenrückseite auf OFF (O) zu stellen.

➔ Vergewissern Sie sich, dass Sie der Einschalter nicht berühren, wenn Sie den Ofen an das Stromnetz anschließen.



fig. 3.2

3.3 ANFÄNGLICHE EINSTELLUNGEN

Vor dem Gebrauch des Ofens müssen die Sprache, das Datum und die aktuelle Uhrzeit eingestellt werden.

3.3.1 Uhrzeit und datum einstellen

Zur Änderung des Datums:

- Mit den Tasten ◀ ▶ das Menü Setup  aufrufen und die Taste ← drücken;
- Mit der Taste + das Passwort "7" anwählen und mit der Taste ← bestätigen;
- Mit der Taste + scrollen, das Untermenü [3] anwählen und mit der Taste ← bestätigen;
- Die Stunden blinken; den Wert mit den Tasten + - ändern und die Taste ▶ antippen;
- Die Minuten blinken; den Wert mit den Tasten + - ändern und die Taste ▶ antippen;
- Der Tag blinkt; den Wert mit den Tasten + - ändern und die Taste ▶ antippen;
- Der Monat blinkt; den Wert mit den Tasten + - ändern und die Taste ▶ antippen;
- Das Jahr blinkt; den Wert mit den Tasten + - ändern und die Taste ▶ antippen;
- Der aktuelle Wochentag blinkt (Montag = 1 ... Sonntag = 7); den Wert mit den Tasten + - ändern;
- Die eingegebenen Daten mit der Taste ← bestätigen.

3.3.2 Display-helligkeit einstellen

Der Benutzer kann einstellen, wie stark die Display-Helligkeit im Standby-Modus gedämpft wird.

- a) Mit den Tasten ◀ ▶ das Menü Setup  aufrufen und die Taste ⏪ drücken;
- b) Mit der Taste + das Passwort "7" anwählen und mit der Taste ⏪ bestätigen;
- c) Mit der Taste + scrollen, das Untermenü [11] anwählen und mit der Taste ⏪ bestätigen;
- d) Mit den Tasten + und - den gewünschten Helligkeitswert einstellen (OFF, 1 ... 5) und mit der Taste ⏪ bestätigen;

3.3.3 Displaymodus einstellen

Der Benutzer kann einstellen, was auf dem Display angezeigt werden soll, wenn dieses auf Standby ist.

- a) Mit den Tasten ◀ ▶ das Menü Setup  aufrufen und die Taste ⏪ drücken;
- b) Mit der Taste + das Passwort "7" anwählen und mit der Taste ⏪ bestätigen;
- c) Mit der Taste + scrollen, das Untermenü [12] anwählen und mit der Taste ⏪ bestätigen;
- d) Mit den Tasten + und - einen der folgenden Werte eingeben:
 - "OFF" • Das Display wird die letzte vom Benutzer betätigte Visualisierungsart zeigen;
 - "1" • Alle Funktionsparameter werden zyklisch gezeigt;
 - "2" • Die Temperatur wird gezeigt Raum (von der Raum-Sonde abgelesen);
 - "3" • Die aktuelle Zeit wird gezeigt;
 - "4" • Die Betriebsautonomie wird gezeigt, welche auf die fehlenden Stunden vor der Wiederfüllung vom Pelletsbehälter hinweist, Ob die Funktion Nachfüllung eingestellt ist.
- e) Die eingegebenen Daten mit der Taste ⏪ bestätigen.

3.3.4 Summerlautstärke einstellen

Die Lautstärke des Signaltons kann nach Bedarf eingestellt werden:

- a) Mit den Tasten ◀ ▶ das Menü Setup  aufrufen und die Taste ⏪ drücken;
- b) Mit der Taste + das Passwort "7" anwählen und mit der Taste ⏪ bestätigen;
- c) Mit der Taste + scrollen, das Untermenü [13] anwählen und mit der Taste ⏪ bestätigen;
- d) Mit den Tasten + und - die gewünschte Lautstärke einstellen (OFF, 1 ... 5) und mit der Taste ⏪ bestätigen;

3.3.5 OPTIMISIERUNG DER VERBRENNUNG

Eine optimale Verbrennung ist im Zusammenhang mit verschiedene Faktoren (Installation Art, Benutzung Art und Wartung, Pellet Eigenschaften, usw.).

Sollten in der Brennschale, nach der Verbrennung, viele Asche Reste bleiben können die Verbrennung Einstellungen (Pellet Art) zwischen 2 weitere Einstellungen geändert werden.

- a) Mit den Tasten ◀ ▶ das Menü Setup  aufrufen und die Taste ⏪ drücken;
- b) Mit der Taste + das Passwort "7" anwählen und mit der Taste ⏪ bestätigen;
- c) Mit der Taste + scrollen, das Untermenü [4] anwählen und mit der Taste ⏪ bestätigen;
- d) Mit den Tasten + und - einen der folgenden Werte eingeben:
 - "1"
 - "2"
 - "3"
- e) Die eingegebenen Daten mit der Taste ⏪ bestätigen.

4 GEBRAUCH DES OFENS

4.1 EINSCHALTEN



Entsichern Sie bevor jedes Start, das die Brennschale komplett leer, sauber und in seiner richtigen Position ist. Zum Einschalten des Ofens die Taste  ein paar Sekunden lang gedrückt halten.

Während der Einschaltphase beginnt das Flammensymbol zu blinken und sobald der Ofen eingeschaltet ist, wechselt es auf Dauerlicht.

- ! Automatische Einschaltung: Der Ofen verfügt über eine automatische Vorrichtung, mit der die Pellets ohne Zuhilfenahme anderer, herkömmlicher Anzündhilfen angezündet werden können.



Zünden Sie den Ofen nicht von Hand an, wenn das automatische Zündsystem nicht richtig funktioniert.

- ! Während der ersten Einschaltung des Ofens können unter Umständen unangenehme Gerüche oder Rauch auftreten, die durch das Verdunsten oder Trocknen einiger verwendeter Materialien verursacht werden. Dieses Phänomen verschwindet mit der Zeit.

Während der ersten Inbetriebnahmen sollten die Räume gut gelüftet werden.

ÖFEN DER SERIE „ERMETICA“:

Die Tür des Feuerraums darf immer nur kurzzeitig geöffnet werden, um zu vermeiden, dass der Türsensor über einen akustischen Alarm meldet, dass die Tür offen steht.

4.2 BEARBEITEN DER PARAMETER

Die Betriebsparameter des Ofens kann wie beschrieben modifiziert werden.



Die eingestellten Werte werden bis zur nächsten Änderung beibehalten, auch wenn der Ofen ausgeschaltet oder vom Stromnetz getrennt wird.

4.3 AUSSCHALTEN

Zum Ausschalten des Ofens die Taste  ein paar Sekunden lang gedrückt halten; das Flammensymbol erlischt.



Bevor der Ofen erneut eingeschaltet wird, sollte gewartet werden, bis er vollständig abgekühlt ist.



Halten Sie sich beim Ausschalten des Ofens strikt an die obigen Anleitungen und schalten Sie ihn unter keinen Umständen durch Trennen der Spannungszufuhr aus.

4.4 BETRIEB MIT RAUMTHERMOSTAT

Wenn der Ofen von einem Raumthermostat (oder Uhrenthermostat) gesteuert wird, muss der Installationstechniker die **Konfiguration 2** einstellen.

In dieser Konfiguration wird der Ofen ausgeschaltet, sobald die Wärmeanforderung des Raumthermostats erfüllt ist (Stromkreis offen).

Der Ofen wird automatisch wieder eingeschaltet, wenn die Temperatur unter den am Raumthermostat eingestellten Wert abfällt (Stromkreis geschlossen).



Bei erstmaliger Einschaltung oder wenn die Ausschaltung direkt am Ofen (Taste ) erfolgt ist, muss der Ofen direkt vom Bedienpanel eingeschaltet werden.

4.5 BETRIEB MIT RAUMTEMPERATURFÜHLER AM OFEN

Der Ofen kann von Hand oder programmiert ein-/ausgeschaltet werden.

Der Ofen regelt die Wärmeleistung anhand der Raum-Temperatur, die von der Sonde abgelesen wird (das heißt, dass der Ofen versucht, die gewünschte Temperatur zu bewahren und so wenig wie möglich zu verbrauchen).

Falls der Benutzer die Funktion „Eco-Mode“ aktiviert hat, moduliert der Ofen nicht, sondern schaltet bei Erreichen der Solltemperatur ab und erst dann wieder ein, wenn die Raumtemperatur unter den eingegebenen Differenzwert abfällt.

Die im Raum gewünschte Temperatur kann im Menü Temperatur eingegeben werden .

5 VERFÜGBARE FUNKTIONEN

5.1 TIMER

Mit dieser Funktion können die benutzerdefinierten Programme für das automatische Ein- und/oder Ausschalten des Ofens eingerichtet, aktiviert und den verschiedenen Wochentagen zugewiesen werden.

Es können bis zu sechs Programme eingerichtet werden.

Für jedes Programm kann eingestellt werden: Einschaltuhrzeit, Ausschaltuhrzeit und gewünschte Temperatur.

Jedem Wochentag können bis zu drei Programme zugewiesen werden.

Die Wochentage sind durch Zahlen gekennzeichnet: Montag = "d1", Dienstag = "d2";...; Sonntag = "d7".

5.1.1 Einstellung der programme

- Mit den Tasten ◀ ▶ das Menü Setup  aufrufen und die Taste ⏪ drücken;
- Mit der Taste + das Passwort "7" anwählen und mit der Taste ⏪ bestätigen;
- Das Untermenü [2] wählen und mit der Taste ⏪ bestätigen;
- Mit den Tasten + - durch die Programme P1...P6; blättern; mit der Taste ⏪ das Programm auswählen, das bearbeitet werden soll;
- Die Stunden der Einschaltuhrzeit blinken; den Wert mit den Tasten + - ändern und die Taste ▶ antippen;
- Die Minuten blinken; den Wert mit den Tasten + - ändern und die Taste ▶ antippen;
- Die Stunden der Ausschaltuhrzeit blinken; den Wert mit den Tasten + - ändern und die Taste ▶ antippen;
- Die Minuten blinken; den Wert mit den Tasten + - ändern und die Taste ▶ antippen;
- Der Wert der gewünschten Temperatur blinkt; den Wert mit den Tasten + - und ▶ ändern;
- Die eingegebenen Daten mit der Taste ⏪ bestätigen.

5.1.2 Zuordnen der programme an die tage

Mit dieser Funktion können einem bestimmten Tag bis zu drei verschiedene Programme zugewiesen werden.

- Mit den Tasten ◀ ▶ das Menü Setup  aufrufen und die Taste ⏪ drücken;
- Mit der Taste + das Passwort "7" anwählen und mit der Taste ⏪ bestätigen;
- Das Untermenü [1] wählen und mit der Taste ⏪ bestätigen.
- Mit den Tasten + - den Tag [d1]...[d7] wählen, dem die Programme zugewiesen werden sollen.
- Mit der Taste ⏪ auswählen.
- Der Wert des ersten zuzuweisenden Programmes blinkt: P1...P6 oder "OFF", um es zu deaktivieren.
- Den Wert mit den Tasten + - ändern und die Taste ▶ antippen.
- Der Wert des zweiten zuzuweisenden Programmes blinkt: P1...P6 oder "OFF", um es zu deaktivieren.
- Den Wert mit den Tasten + - ändern und die Taste ▶ antippen.
- Der Wert des dritten zuzuweisenden Programmes blinkt: P1...P6 oder "OFF", um es zu deaktivieren.
- Den Wert mit den Tasten + - ändern und die Taste ⏪ antippen, um die eingegebenen Daten zu bestätigen.

5.1.3 Timer aktivieren/deaktivieren

- Den Cursor mit den Pfeiltasten ◀ ▶ auf das Menü Timer  setzen.
- Mit der Taste ⏪ auswählen.
- Mit den Tasten + - blättern und wählen: "ON" zur Aktivierung des Timers oder "OFF" zur Deaktivierung.
- Die Taste ⏪ drücken, um die Auswahl zu bestätigen.

Wenn der Timer aktiviert ist, erscheint das Symbol  dauerhaft, um anzuzeigen, dass der Timer aktiv ist.

5.2 SPARFUNKTION “ECO MODE“

Bei Aktivierung dieser Funktion wird der Ofen bei Erreichen der gewünschten Raumtemperatur ausgeschaltet. Wenn diese Funktion nicht aktiviert ist, moduliert der Ofen seinen Betrieb, um die gewünschte Temperatur bei geringstmöglichem Verbrauch zu halten.

Die Funktion “Eco Mode” ist nur in Konfiguration 1 verfügbar.

Zur Aktivierung/Deaktivierung dieser Funkt:

- Mit den Tasten das Menü Setup aufrufen und die Taste drücken;
- Mit der Taste das Passwort “7” anwählen und mit der Taste bestätigen;
- Das Untermenü wählen und mit der Taste bestätigen.
- Mit den Tasten einen der folgenden Werte eingeben:
 - Die Funktion “Eco Mode” wird aktiviert;
 - Die Funktion “Eco Mode” wird gesperrt.
- Die eingegebenen Daten mit der Taste bestätigen.

5.3 FUNKTION EINSCHALTDIFFERENZ

Die Einschaltdifferenz ist der unterhalb der Ausschalttemperatur liegender Wert in Grad Celsius, bei dessen Überschreitung der Ofen automatisch wieder eingeschaltet wird. Wenn der Ofen zum Beispiel auf Ausschaltung bei 20°C eingestellt ist (Eco Mode aktiv) und eine „Einschaltdifferenz“ von 4°C eingegeben wird, schaltet sich der Ofen ein, sobald eine Temperatur von kleiner oder gleich 16°C gemessen wird.

Zur Änderung des Wertes der Einschaltdifferenz:

- Mit den Tasten das Menü Setup aufrufen und die Taste drücken;
- Mit der Taste das Passwort “7” anwählen und mit der Taste bestätigen;
- Das Untermenü anwählen und mit der Taste bestätigen;
- Der Wert blinkt; den Wert mit den Tasten und ändern (0,5 ... 5,0°C);
- Die Taste drücken, um den eingegebenen Wert zu bestätigen.

5.4 WIEDEREINSCHALTEN NACH STROMAUSFALL

Bei einem Stromausfall wird der Ofen bei Rückkehr der Stromversorgung nach Prüfung der erforderlichen Voraussetzungen automatisch wieder eingeschaltet.

5.5 FUNKTION „TASTATURSPERRE“

Mit dieser Funktion kann die Verwendung des Bedienpanels blockiert werden, um unbeabsichtigte Änderungen zu vermeiden.

Zur Aktivierung/Deaktivierung dieser Funktion:

- Mit den Tasten das Menü Setup aufrufen und die Taste drücken;
- Mit der Taste das Passwort “7” anwählen und mit der Taste bestätigen;
- Das Untermenü wählen und mit der Taste .
- Mit den Tasten einen der folgenden Werte eingeben:
 - “OFF” Tastatursperre deaktiviert
 - “Lo” Nur die Ein-/Ausschalttaste bleibt aktiviert
 - “Hi” Tastatursperre aktiviert
- Die eingegebenen Daten mit der Taste bestätigen.

5.6 FROSTSCHUTZFUNKTION

(Nur in der Konfiguration 1)



Es ist möglich, eine Tieftemperatur anzulegen, unter welcher der Ofen wieder angeht (außer den programmierten Zeitspannen und nur wenn das Schaltuhr/Timer-Programm aktiv ist).

Zur Änderung des Temperaturwerts „Frostschutz“:















- Mit den Tasten das Menü Setup aufrufen und die Taste drücken;
- Mit der Taste das Passwort “7” anwählen und mit der Taste bestätigen;
- Das Untermenü wählen und mit der Taste bestätigen;
- Der Wert blinkt; Wert mit den Tasten ändern (OFF; 3...20°C);
- Den eingegebenen Wert mit der Taste bestätigen.

6 VERWALTUNG DER ALARMMELDUNGEN

Bei Auftreten einer Betriebsstörung wird die folgende Prozedur aktiviert:

- 1) Akustischer Alarm (Piepton);
- 2) Eine der folgenden System-LEDs leuchtet auf:   ;
- 3) Wenn die Störung einen Fehler betrifft, wird der Ofen ausgeschaltet

Durch anhaltendes Drücken der Taste „Abbrechen“  wird der Fehlercode auf dem Display angezeigt:

FEHLERCODE MELDUNG	BESCHREIBUNG	MÖGLICHE URSACHEN	LED
E001	Bedienpanel defekt	Defekt des Bedienfelds	
E002	Kommunikationsfehler Fernbedienungs-signal	Defekt des Bedienfelds	
E004	Kommunikationsfehler	Verbindungskabel zwischen Platine und Bedienpanel unterbrochen oder getrennt. Wenn dieser Fehler während des Konfigurationswechsels auftritt, kann er ignoriert werden.	
E101	Fehlgeschlagene Einschaltung	Keine Pellets vorhanden Pelletsqualität Einschaltsystem defekt Brenntopf verschmutzt	
E105	Pellet-Sonde Fehler	Pellet-Sonde nicht angeschlossen oder defekt	
E108*	Sicherheitsfehler	Einfülltür oder -klappe offen	
E109	Fehler wegen Druck oder Wärmeschutz	Rauchabzugssystem verschmutzt Dichtungen verschlissen Ungenügende Verbrennungsluft Probleme durch Überhitzung des Pelletbehälters	
E110	Fehlbetrieb des Temperaturfühlers	Lufttemperaturfühler defekt	
E111	Fehlbetrieb des Abgasfühlers	Abgastemperaturfühler defekt	
R001	Niedriger Pelletfüllstand (<i>Symbol blinkt</i>)	Pellets fast leer	
R002	Hinweis auf programmierte Wartung (<i>Symbole blinken</i>)	Der Ofen fordert regelmäßig die Durchführung der Wartung durch einen Fachtechniker an	
R007	Fehlbetrieb des Druckfühlers. (<i>Symbole blinken</i>)	Druckfühler oder Platine defekt.	
----	Ofenreinigung	Brennkammer, Brenntopf oder Rauchabzugssystem verschmutzt. Druckmessrohre getrennt oder verstopft. Verbrennungslufteintritt verstopft.	
----	Fehlgeschlagene Einschaltung	Pellets aufgebraucht; Zündwiderstand defekt; Dichtungen verschlissen; falsche Position des Brenntopfes	

* Es gilt lediglich für die Modelle mit Sicherheitsmikroschalter an der Feuerraum Tür oder an der Pelletsbehälter-Deckel.

Nach Überprüfung der Art der Meldung kann der Alarm zurückgesetzt werden, indem die Ein-/Ausschalttaste einige Sekunden lang gedrückt wird .

Falls der Fehlercode "E109" ist, muss vor Zurücksetzen des Alarms der Thermostat mit manueller Rücksetzung an der Ofenrückseite wieder aktiviert werden (Abb. 6.1) (das sollte vom Kundendienst ausgeführt werden). Anschließend kann der Ofen erneut eingeschaltet werden.



Bevor der Ofen neu gestartet wird, müssen folgende Punkte beachtet werden:

- Der Ofen muss abgekühlt sein.
- Die Brennschale muss sauber und frei von Schlacke oder Pellet Rückstände sein.
- Die Brennschere muss in der richtigen Position in seinem Sitz sein.
- Die Ofen Tür und der Pellet Tank Deckel müssen zu sein.



fig. 6.1

INDEX

1 CONFIGURATION INITIALE

- 1.1 BRANCHEMENT À UN CHRONO-THERMOSTAT EXTÉRIEUR
- 1.2 REGLEMENT DES DEUX VENTILATEURS ARRIÈRE

2 PANNEAU DE COMMANDE

- 2.1 DESCRIPTION
- 2.2 UTILISATION DU CLAVIER DE COMMANDE
- 2.3 PARAMÈTRES DE FONCTIONNEMENT

3 OPERATIONS PRELIMINAIRES

- 3.1 REMPLISSAGE DES PELLETS
- 3.2 ALIMENTATION ELECTRIQUE
- 3.3 PARAMÉTRAGES PRÉLIMINAIRES

4 UTILISATION DU POELE

- 4.1 ALLUMAGE
- 4.2 MODIFICATION DES PARAMETRES
- 4.3 EXTINCTION
- 4.4 FONCTIONNEMENT AVEC UN THERMOSTAT AMBIANT
- 4.5 FONCTIONNEMENT AVEC UNE SONDE AMBIANTE INSTALLÉE SUR LE POËLE

5 FONCTIONS DISPONIBLES

- 5.1 FONCTION TIMER
- 5.2 FONCTION ÉCONOMIE "ECO MODE"
- 5.3 FONCTION DELTA DE RALLUMAGE
- 5.4 RALLUMAGE APRÈS UNE COUPURE DE COURANT
- 5.5 FONCTION "BLOCAGE CLAVIER"
- 5.6 FONCTION ANTIGEL

6 GESTION DES ALARMES

1 CONFIGURATION INITIALE

En fonction du type d'installation, le poêle doit être configuré de façon propre afin d'optimiser son fonctionnement. Pour ce faire, alimenter d'abord le poêle en appuyant sur l'interrupteur situé au dos.

- a) A l'aide des touches flèche ◀ ▶, sélectionner le menu Configuration ⚙ et appuyer sur ⏪;
- b) Sélectionner le mot de passe "7" avec la touche + et confirmer avec la touche ⏪;
- c) Sélectionner le sous-menu [30] à l'aide des touches + - ; "r--0" se met à clignoter.
- d) Appuyer sur la touche ⏪ et entrer "54" avec les touches + -;
- e) Appuyer sur la touche ⏪ pour confirmer.
- f) La configuration actuellement en cours s'affiche.
- g) Pour modifier, appuyer sur la touche ⏪ et entrer le chiffre correspondant à la nouvelle configuration avec les touches + -.
- h) Appuyer sur la touche ⏪ pour confirmer.

! Il est possible qu'un message d'alarme s'affiche pendant quelques secondes après avoir modifié la configuration. L'ignorer et éteindre le poêle en appuyant sur l'interrupteur situé au dos. Attendre quelques secondes, puis le rallumer.

DEUX CONFIGURATIONS DIFFÉRENTES SONT PROGRAMMABLES:

CONFIGURATION 1 (par défaut)

Cette configuration convient aussi pour allumer et éteindre le poêle manuellement ou de façon programmée.

Le poêle module sa puissance en fonction de la température ambiante lue par la sonde à bord.

Il est possible d'activer la fonction "Eco-mode" afin que le poêle s'éteigne lorsque la température programmée a été atteinte et se rallume une fois que la température ambiante descend.

Dans cette configuration il est possible de sélectionner aussi la fonction antigel.

CONFIGURATION 2

Mettre au point cette configuration lorsque le poêle est géré par un thermostat (ou chrono-thermostat) extérieur.

Dans cette configuration le poêle s'éteint lorsque le thermostat extérieur se déclenche une fois que la température programmée aura été atteinte.

Dans cette configuration il n'est pas possible de sélectionner la fonction antigel.

1.1 BRANCHEMENT À UN CHRONO-THERMOSTAT EXTÉRIEUR

Il est possible de connecter un chrono-thermostat extérieur qui éteint et allume le poêle en fonction de la température programmée.

Le thermostat extérieur doit être connecté aux bornes 1 et 2 du domino situé à l'arrière du poêle et qu'ils sort de production branchés au sonde extérieure. Débranchez la sonde externe, puis branchez à sa place les deux contacts du thermostat.

Il est important de placer le poêle dans la **configuration 2** en suivant les instructions reportées dans le paragraphe "Configuration initiale".

! Après avoir installé le chrono-thermostat, le premier allumage du poêle doit s'effectuer manuellement pendant que le chrono-thermostat est en mode "appel". Procéder de même après une coupure de courant, ainsi qu'après une extinction manuelle du poêle.

! Pour ne pas le superposer à des tranches horaires de fonctionnement, il est conseillé de désactiver (programmer sur OFF) le timer du poêle.

1.2 REGLEMENT DES DEUX VENTILATEURS ARRIÈRE

Lors de l'installation, il est possible de régler la vitesse des deux ventilateurs arrière, en fonction du type de système de distribution réalisé (longueur, section, matériau utilisé ...)

Au démarrage du poêle et après avoir allumé les deux ventilateurs arrière dans le menu de ventilation, vous pouvez ajuster les deux ventilateurs arrière en agissant sur les potentiomètres situés à l'arrière du poêle (fig 1.1 -D-) jusqu'à ce qu'ils atteignent le niveau de ventilation souhaité.

1.2.1 Branchement des ventilateurs arrière à un thermostat externe

Il est possible de connecter deux thermostats externes au domino fixé derrière le poêle afin que vous puissiez allumer et éteindre les ventilateurs arrière en fonction de la température réglée sur le thermostat.

Pour bénéficier de cette fonctionnalité, il est nécessaire que la position réglée par le tableau des deux ventilateurs arrière soit sur ON.

Le thermostat qui commande le ventilateur de gauche sera connecté aux bornes 3 et 4 du domino.

Le thermostat qui commande le ventilateur de droite sera connecté aux bornes 5 et 6 du domino.

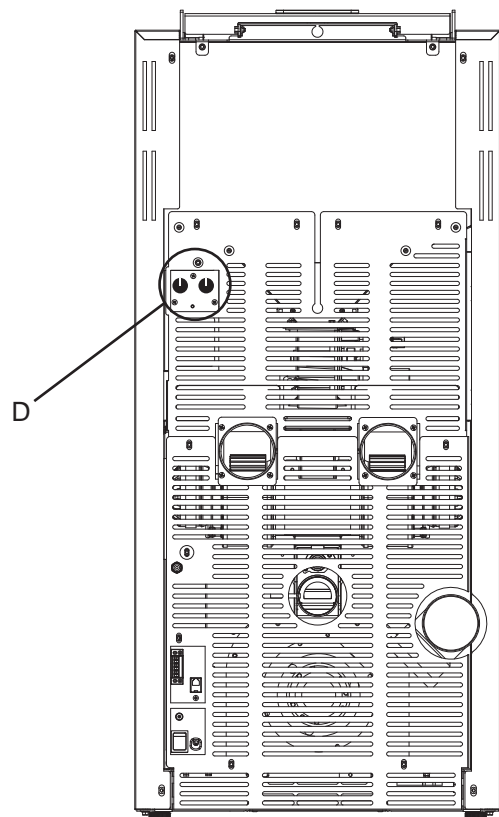

fig. 1.1

2 PANNEAU DE COMMANDE

Avant d'entamer la lecture du manuel, consulter la description du poêle contenue dans le manuel en annexe.

2.1 DESCRIPTION

Composition du clavier de commande:







- A) la partie haute avec les LEDS d'état et les icônes rétro éclairées identifiant chaque fonction,
- B) écran à LEDS,
- C) touche d'allumage (⏻),
- D) touche "Annuler" et affichage "Alarme" (⏮),
- E) deux touches flèche pour se déplacer dans les différents menus (⏪ ⏩);
- F) deux touches (+) et (-) pour accéder aux sous-menus et modifier les paramètres de fonctionnement;
- G) touche envoi (↵) pour confirmer le paramètre ou la sélection.









fig. 2.1

 S'agissant d'un clavier capacitif tactile, il suffit juste d'appuyer les touches pour les activer.

2.1.1 Leds d'état

ICONE	MESSAGE	DESCRIPTION
	Pellets en cours d'épuisement.	Elle signale qu'il faut remplir la trémie de pellets
	Entretien	Elle signale qu'il faut effectuer une opération d'entretien
	Assistance	Elle signale le déclenchement d'une alarme
	Récepteur de la télécommande	Il reçoit les commandes par la télécommande (optionnel)
	Timer activé	Elle signale l'activation de la fonction timer
	Led signalant l'état (près de la touche (⏻))	Led allumée: signale que le poêle est en marche Led clignotante: signale que le poêle est en cours d'allumage ou en veille Led éteint: signale que le poêle est éteint









2.1.2 Description du menu

ICON	FUNCTION	DESCRIPTION	VALEURS
	Puissance	Mise au point de la puissance de fonctionnement	1..5
	Ventilation	Réglez la puissance du ventilateur de l'air ambiant.	c: OFF,1..5; A; Hi r: ON/OFF L: ON/OFF
	Temperature	Affiche la température ambiante et permet de programmer la température voulue.	6°C .. 51°C
	Fuel	Fonction non utilisée	
	Timer	Active ou désactive la minuterie. Quand la minuterie est activée l'icône  est affichée fixe.	ON - OFF

ICON	FUNCTION	SUBMENU	DESCRIPTION	VALEURS
	Mise au point	[1] Minuterie hebdomadaire	Affectation des programmes (max 3) aux différents jours de la semaine	[d1] ... [d7]
		[2] Programmes	Configuration des programmes	[P1] ... [P6]
		[3] Horloge / date	Réglage de l'horloge et de la date	
		[4] Heures résiduelles	Affiche le nombre d'heures restantes jusqu'au prochain entretien préconisé. La valeur "Hi" indique un nombre supérieur à 999 heures.	
		[5] Informations de système	Affiche la version du logiciel en cours	
		[6] Fonction pas activé		
		[7] Fonction Eco	Active ou désactive le mode Eco qui permet l'arrêt et le rallumage automatique en fonction de la température ambiante (uniquement en configuration 1).	OFF; Eco
		[8] Delta de rallumage	Différence en degrés, par rapport à la température ambiante, en dessous de laquelle le poêle se rallume (uniquement en configuration 1).	0,5 ... 5,0°C
		[9] Température hors-gel	Température minimum en dessous de laquelle le poêle s'allume (uniquement en configuration 1).	OFF; 3 ... 20°C
		[10] Verrouillage clavier	Configuration verrouillage des touches	OFF; Lo; Hi
		[11] Luminosité écran	Règle le degré de luminosité de l'écran	OFF; 1 ... 5
		[12] Mode affichage	Configuration de l'affichage des données	OFF; 1 ... 4
		[13] Volume avertisseur sonore	Configuration du volume de l'avertisseur sonore	OFF; 1 ... 5
		[14] Combustion	C'est possible régler trois configurations	1 ... 3
		[15] Fonction pas activé		
[30] Menu installateur	Modifie/affiche la configuration du poêle	PWD: "54"		
[40] Menu de service	Menu destiné au SAV.			

Les sous-menus [30] et [40] du menu Configuration sont protégés par un mot de passe et sont à l'usage exclusif du service d'assistance technique.

2.2 UTILISATION DU CLAVIER DE COMMANDE

- L'effleurement des touches flèche   fait défiler les différents menus qui s'illuminent au fur et à mesure.
- Pour modifier les réglages d'une fonction donnée il suffit d'appuyer sur la touche  quand elle s'affiche et d'en modifier les valeurs avec les touches  .
- Appuyer de nouveau sur la touche  pour confirmer la modification.
- En général tous les paramètres qui clignotent peuvent être modifiés à l'aide des touches  .
- La touche "Annuler"  permet d'annuler la modification; Un effleurement prolongé permet d'afficher le code de l'alarme qui s'est éventuellement déclenchée.

2.3 PARAMÈTRES DE FONCTIONNEMENT

Le fonctionnement du poêle dépend des paramètres de Puissance, Ventilation et Température réglés par l'utilisateur.

2.3.1 Modification de la puissance

La puissance correspond à la quantité de chaleur produite par le poêle, et influe donc directement sur la consommation.

Pour modifier la puissance:

- a) A l'aide des touches ◀ ▶ sélectionner le menu puissance 🔥 et appuyer sur ↵;
- b) Le paramètre de la puissance se met à clignoter; le modifier avec les touches + - (1 minimum, ..., 5 maximum).
- c) Appuyer la touche ↵ pour confirmer la mise au point.

2.3.2 Modification de la ventilation

Pour changer la valeur de la ventilation:

- a) Déplacez-vous avec les touches ◀ ▶ au menu ventilation 🌿 et appuyer sur la touche ↵;
- b) Utilisez les touches + - pour vous déplacez entre le ventilateur central [c], le ventilateur droit [r] et le ventilateur gauche [L];
- a) Appuyer sur la touche ↵ pour sélectionner le ventilateur souhaité ;
- b) pour sélectionner le ventilateur souhaité [c]; et changez les valeurs avec les touches + et - :
 - "OFF" = La ventilation est totalement exclue. Le poêle fonctionnera uniquement en convection naturelle;
 - "1" Minimum ,..., "5" Maximum;
 - "A" = fonctionnement automatique (le poêle règlera la vitesse en fonction de la température de l'air ambiant);
 - "Hi" = Vitesse ultra-rapide (utiliser uniquement en cas de nécessité, pour chauffer rapidement une pièce);
 - Appuyez sur la touche ↵ pour confirmer les paramètres définis.

Si le ventilateurs droit (r) ou gauche (L) sont sélectionnées, c'est possible exclusivement d'activer les valeurs On et OFF.

Dans le cas où le ventilateur central est réglé sur OFF, et au moins un des deux ventilateurs arrière est sur ON, le ventilateur centrale se règlera automatiquement au minimum.

2.3.3 Modification de la température ambiante

La modification de ce paramètre définit la température ambiante que l'on souhaite atteindre et qui sera directement lue par la sonde installée sur le poêle.

Pour modifier la valeur de la température voulue:

- a) A l'aide des touches ◀ ▶ sélectionner le menu température 🌡 et appuyer sur ↵;
- b) Le paramètre en cours se met à clignoter, le modifier avec les touches + -;
- c) Appuyer la touche ↵ pour confirmer la mise au point.

3 OPERATIONS PRELIMINAIRES

3.1 REMPLISSAGE DES PELLETS

La première opération à effectuer avant d'allumer le poêle est celle de remplir la trémie de pellets.

Les pellets doivent être versés dans la trémie avec une petite pelle.

Ne pas vider directement le sac dans la trémie pour ne pas y jeter de la sciure ou des corps étrangers qui pourraient nuire au bon fonctionnement du poêle, et ne pas verser de pellets en dehors de la trémie.



Veiller à bien refermer le couvercle de la trémie après avoir chargé les pellets. Un interrupteur de sécurité (uniquement sur les modèles qui le prévoit) en vérifie la fermeture (IS en fig. 3.1) et met en alarme le poêle si le couvercle est laissé ouvert pour une période supérieure à 60 secondes avec le poêle en fonction.

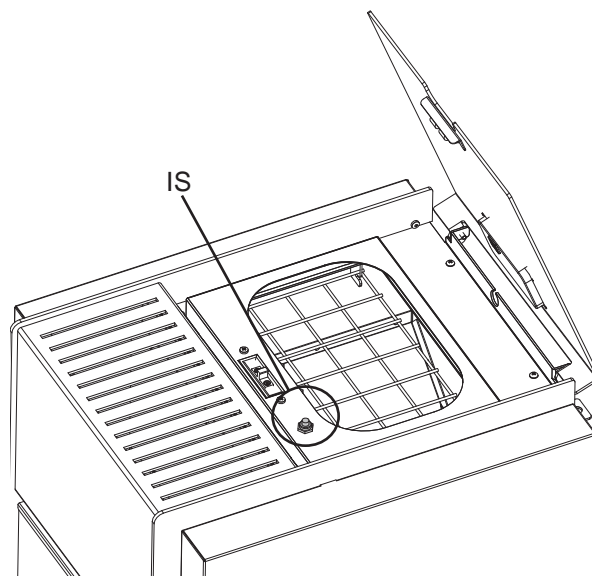

fig. 3.1

3.2 ALIMENTATION ELECTRIQUE

Brancher le poêle au secteur en plaçant l'interrupteur d'allumage situé au dos du poêle sur "I" (Fig. 3.2). La mise sous tension est signalée par une série de bips par intermittence et par l'allumage de l'écran.



En prévision d'une longue période d'inactivité, il est conseillé de placer l'interrupteur au dos du poêle sur OFF (O).



En branchant le poêle à une prise de courant, s'assurer de ne pas toucher le panneau de commande.

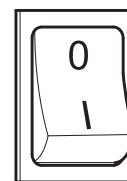

fig. 3.2

3.3 PARAMETRAGES PRELIMINAIRES

Avant d'utiliser le poêle, il faut programmer la langue, la date et l'heure en cours.

3.3.1 Paramétrage de l'heure et de la date

Pour modifier la date:

- A l'aide des touches ◀ ▶, sélectionner le menu Configuration ⚙ et appuyer sur ⏪;
- Sélectionner le mot de passe "7" avec la touche + et confirmer avec la touche ⏪;
- À l'aide de la touche +, sélectionner le sous-menu [3] et confirmer avec la touche ⏪;
- Le paramètre de l'heure se met à clignoter, le modifier avec les touches + - puis appuyer la touche ▶;
- Le paramètre des minutes se met à clignoter, le modifier avec les touches + - puis appuyer la touche ▶;
- Le paramètre du jour se met à clignoter, le modifier avec les touches + - puis appuyer la touche ▶;
- Le paramètre du mois se met à clignoter, le modifier avec les touches + - puis appuyer la touche ▶;
- Le paramètre de l'année se met à clignoter, le modifier avec les touches + - puis appuyer la touche ▶;
- Le paramètre du jour de la semaine en cours (lundi = 1... dimanche = 7) se met à clignoter, le modifier avec les touches + -;
- Appuyer la touche ⏪ pour confirmer la mise au point.

3.3.2 Mise au point de la luminosité de l'écran

Il est possible de mettre au point la luminosité de l'écran lorsqu'il est en mode veille.

- A l'aide des touches ◀ ▶, sélectionner le menu Configuration ⚙️ et appuyer sur ⏪;
- Sélectionner le mot de passe "7" avec la touche + et confirmer avec la touche ⏪;
- À l'aide de la touche +, sélectionner le sous-menu [11] et confirmer avec la touche ⏪;
- Régler la luminosité souhaitée (OFF, 1 ... 5) à l'aide des touches + et -, puis confirmer avec la touche ⏪.

3.3.3 Mise au point de l'affichage

Il est possible de mettre au point les objets que l'on souhaite afficher lorsque l'écran est en veille.

A l'aide des touches flèche ◀ ▶ sélectionner le menu de mise au point ⚙️;

- A l'aide des touches ◀ ▶, sélectionner le menu Configuration ⚙️ et appuyer sur ⏪;
- Sélectionner le mot de passe "7" avec la touche + et confirmer avec la touche ⏪;
- À l'aide de la touche +, sélectionner le sous-menu [12] et confirmer avec la touche ⏪;
- Mettre au point avec les touches + et - l'un des paramètres suivants:
 - "OFF" • L'afficheur va vous montrer la dernière visualisation réalisée par le client;
 - "1" • Vous allez visualiser cycliquement tous les paramètres;
 - "2" • Vous allez visualiser la température (lue par la sonde ambiante).
 - "3" • Vous allez visualiser l'heure actuelle
 - "4" • Vous allez visualiser les heures d'autonomie avant de recharger le réservoir d'alimentation, si la fonction "ravitaillement" a été validé.
- Appuyer la touche ⏪ pour confirmer la mise au point.

3.3.4 Mise au point du volume de l'avertisseur sonore

Il est possible de mettre au point le volume de l'avertisseur sonore en fonction de ses exigences.

- A l'aide des touches ◀ ▶, sélectionner le menu Configuration ⚙️ et appuyer sur ⏪;
- Sélectionner le mot de passe "7" avec la touche + et confirmer avec la touche ⏪;
- À l'aide de la touche +, sélectionner le sous-menu [13] et confirmer avec la touche ⏪;
- Régler le volume souhaité (OFF, 1 ... 5) à l'aide des touches + et -, puis confirmer avec la touche ⏪.

3.3.5 Optimisation de la combustion



Une combustion optimale est liée à différents facteurs (type d'installation, conditions de fonctionnement et d'entretien, qualité du combustible etc..)

En ligne général, si à la fin de la combustion, dans le brasero il y a pas mal de résidus, il vaut mieux modifier les configurations du combustible (en augmentant sa valeur) jusqu'à trouver la meilleure solution possible.

- A l'aide des touches ◀ ▶, sélectionner le menu Configuration ⚙️ et appuyer sur ⏪;
- Sélectionner le mot de passe "7" avec la touche + et confirmer avec la touche ⏪;
- À l'aide de la touche +, sélectionner le sous-menu [4] et confirmer avec la touche ⏪;
- Mettre au point avec les touches + et - l'un des paramètres suivants:
 - "1"
 - "2"
 - "3"
- Appuyer la touche ⏪ pour confirmer la mise au point.

4 UTILISATION DU POËLE

4.1 ALLUMAGE

-  Avant chaque allumage, assurez-vous que le brasero est vide et correctement positionné dans son logement. Pour allumer le poêle, appuyer sur la touche  pendant quelques secondes. L'icône de la flamme se met à clignoter pendant la phase d'allumage, puis reste allumée fixement pour signaler l'allumage du poêle.
- ! Allumage automatique: le poêle est équipé d'un dispositif automatique permettant d'allumer les pellets sans recourir aux allume-feux traditionnels.
-  Ne pas allumer manuellement le poêle si le dispositif d'allumage automatique est défectueux.
- ! Lors du premier allumage du poêle, de mauvaises odeurs peuvent se dégager provoquées par l'évaporation ou le séchage de certains matériaux de construction. Ces odeurs disparaîtront au fur et à mesure. Il est conseillé de bien ventiler les pièces lors des premiers allumages.

POÊLES DE LA GAMME "ÉTANCHE":

Ne pas laisser la porte du foyer ouverte pour éviter que le capteur de fermeture ne détecte l'état de porte ouverte et ne déclenche une alarme sonore.

4.2 MODIFICATION DES PARAMETRES

Il est possible modifier les paramètres de fonctionnement du poêle comme indiqué.

-  Les paramètres demeurent inchangés tant qu'ils n'auront pas été modifiés, y compris après l'extinction du poêle ou son débranchement.

4.3 EXTINCTION

Pour éteindre le poêle, appuyer la touche  pendant quelques secondes ; l'icône de la flamme s'éteindra.

-  Pour rallumer le poêle, il est conseillé d'attendre son refroidissement complet.

-  Il est conseillé d'éteindre le poêle en suivant scrupuleusement les indications ci-dessus et jamais en coupant l'arrivée de l'alimentation électrique.

4.4 FONCTIONNEMENT AVEC UN THERMOSTAT AMBIANT

En cas de contrôle du poêle avec un thermostat (ou chrono-thermostat) extérieur l'installateur doit programmer la configuration 2. Dans cette configuration, le poêle s'éteint lorsque le thermostat extérieur se déclenche (circuit ouvert).

Le poêle se rallume automatiquement lorsque la température descend sous la valeur mise au point sur le thermostat extérieur (circuit fermé).

-  **Au premier allumage ou si le poêle a été éteint depuis le clavier de commande (touch ) , le rallumage doit s'effectuer depuis le clavier de commande.**

Le poêle s'arrêtera aussi si la température continue à augmenter malgré la modulation. Dans ce cas le poêle va se mettre en marche seulement si la différence entre la valeur de la température choisie et la température réelle est supérieur à 20°C.

4.5 FONCTIONNEMENT AVEC UNE SONDE AMBIANTE INSTALLÉE SUR LE POËLE

Le poêle peut être allumé/éteint manuellement ou de façon programmée.

Le poêle module sa puissance en fonction de la température ambiante lue par la sonde à bord (le poêle maintient la température mise au point en consommant le moins possible).

Si la fonction "Eco-mode" a été activée , au lieu de moduler sa puissance, le poêle s'éteint lorsque la température programmée a été atteinte, et se rallume lorsque la température ambiante descend sous le delta défini.

Il est possible de mettre au point la température ambiante souhaitée dans le menu température .

5 FONCTIONS DISPONIBLES

5.1 FONCTION TIMER

Cette fonction permet de programmer et d'assigner aux différents jours de la semaine des programmes personnalisés permettant d'allumer et/ou d'éteindre automatiquement le poêle.



























Il est possible de mettre au point jusqu'à six programmes personnalisés.

Dans chaque programme on peut mettre au point l'heure d'allumage et d'extinction ainsi que la température souhaitée.

Il est possible d'assigner jusqu'à 3 programmes pour chaque jour de la semaine.





















Les jours de la semaine sont identifiés par un chiffre allant de 1 à 7 : lundi = "d1", mardi = "d2" ;... ; dimanche = "d7".

5.1.1 Mise au point des programmes







- A l'aide des touches  , sélectionner le menu Configuration  et appuyer sur .
- Sélectionner le mot de passe "7" avec la touche  et confirmer avec la touche .
- Sélectionner le sous-menu  et confirmer avec la touche .
- A l'aide des touches   faire défiler les programmes P1...P6 ; à l'aide de la touche  sélectionner celui que l'on souhaite modifier.
- Le paramètre de l'heure d'allumage se met à clignoter; modifier le paramètre avec les touches   puis appuyer la touche .
- Le paramètre des minutes se met à clignoter; modifier le paramètre avec les touches   puis appuyer la touche .
- Le paramètre de l'heure d'extinction se met à clignoter; modifier le paramètre avec les touches   puis appuyer la touche .
- Le paramètre des minutes se met à clignoter; modifier le paramètre avec les touches   puis appuyer la touche .
- Le paramètre de la température souhaitée se met à clignoter; modifier le paramètre avec les touches   puis appuyer la touche .
- Appuyer la touche  pour confirmer la mise au point.

5.1.2 Assignation des programmes aux jours de la semaine

Cette fonction permet d'assigner jusqu'à 3 programmes différents à un jour déterminé.

- A l'aide des touches  , sélectionner le menu Configuration  et appuyer sur .
- Sélectionner le mot de passe "7" avec la touche  et confirmer avec la touche .
- Sélectionner le sous-menu  et confirmer avec la touche .
- Sélectionner avec les touches   le jour [d1]...[d7] auquel on souhaite associer les programmes;
- Le sélectionner avec la touche .
- Le paramètre du premier programme à assigner se met à clignoter: P1...P6 ou "OFF" pour le désactiver;
- Modifier le paramètre avec les touches   puis appuyer la touche .
- Le paramètre du deuxième programme à assigner se met à clignoter: P1...P6 ou "OFF" pour le désactiver;
- Modifier le paramètre avec les touches   puis appuyer la touche .
- Le paramètre du troisième programme à assigner se met à clignoter: P1...P6 ou "OFF" pour le désactiver;
- Modifier le paramètre avec les touches   puis appuyer la touche  pour confirmer la mise au point.

5.1.3 Activation / désactivation du timer











- A l'aide des touches flèche   sélectionner le menu Timer .
- Confirmer avec la touche .
- A l'aide des touches   faire défiler et sélectionner: "ON" pour activer le timer ou "OFF" pour le désactiver.
- Appuyer la touche  pour confirmer la sélection.

Quand la minuterie est activée l'icône fixe  s'affiche .

5.2 FONCTION ÉCONOMIE “ECO MODE”

Cette fonction éteint le poêle lorsque la température ambiante programmée est atteinte. Si cette fonction n'est pas activée, le poêle module son fonctionnement pour maintenir la température programmée en consommant le moins possible. La fonction “Eco Mode” n'est disponible que dans la configuration 1.











Pour activer/désactiver cette fonction:

- A l'aide des touches  , sélectionner le menu Configuration  et appuyer sur .
- Sélectionner le mot de passe “7” avec la touche  et confirmer avec la touche .
- Sélectionner le sous-menu  et confirmer avec la touche .
- Mettre au point avec les touches   l'un des paramètres suivants:
 - ECO → Validation de la fonction “Eco Mode”
 - OFF → Désactivation de la fonction “Eco Mode”
- Appuyer la touche  pour confirmer la mise au point.

5.3 FONCTION DELTA DE RALLUMAGE

Le delta de rallumage est le nombre de degrés sous la température d'extinction au-delà duquel le poêle se rallume automatiquement. Par exemple, si le poêle est programmé pour s'éteindre à 20°C (Eco Mode activé) et le “Delta de rallumage” a été défini à 4°C, le poêle se rallumera lorsqu'il aura relevé une température inférieure ou égale à 16°C.

Pour modifier la valeur du delta de rallumage:

- A l'aide des touches  , sélectionner le menu Configuration  et appuyer sur .
- Sélectionner le mot de passe “7” avec la touche  et confirmer avec la touche .
- Sélectionner le sous-menu  et confirmer avec la touche .
- Le paramètre se met à clignoter, le modifier avec les touches  et  (0,5 ... 5,0°C);
- Appuyer sur la touche  pour confirmer.













5.4 RALLUMAGE APRÈS UNE COUPURE DE COURANT

Après une interruption de courant, le poêle se rallume automatiquement et effectue un autodiagnostic au retour de l'alimentation.

5.5 FONCTION “BLOPAGE CLAVIER”

Cette fonction permet de bloquer le clavier de commande afin de prévenir toute modification intempestive.











Pour activer/désactiver cette fonction:

- A l'aide des touches  , sélectionner le menu Configuration  et appuyer sur .
- Sélectionner le mot de passe “7” avec la touche  et confirmer avec la touche .
- Sélectionner le sous-menu  et confirmer avec la touche .
- à l'aide des touches   mettre au point l'un des paramètres suivants:
 - “OFF” Verrouillage clavier désactivé
 - “Lo” seule la touche allumage/extinction  est activée
 - “Hi” Verrouillage clavier activé
- Appuyer la touche  pour confirmer la mise au point.

5.6 FONCTION ANTIGEL





(Uniquement en configuration 1)















Il est possible de programmer une température minimum en dessous de laquelle le poêle s'allume (en-dehors des tranches horaires programmées). Pour modifier le paramètre de la température “antigel”:

- A l'aide des touches  , sélectionner le menu Configuration  et appuyer sur .
- Sélectionner le mot de passe “7” avec la touche  et confirmer avec la touche .
- Sélectionner le sous-menu  et confirmer avec la touche .
- Le paramètre se met à clignoter, le modifier avec les touches   (OFF; 3...20°C);
- Appuyer la touche  pour confirmer la mise au point.

6 GESTION DES ALARMES

Un dysfonctionnement est signalé par la procédure suivante:

- 1) avertissement sonore (bip);
- 2) allumage de l'une des icônes suivantes:   ;
- 3) s'il s'agit d'une alarme, le poêle s'éteint;
- 4) l'effleurement prolongé de la touche "annuler"  affiche le code de l'alarme:

CODE ALARME / MESSAGE	DESCRIPTION	CAUSES PROBABLES	LED
E001	Clavier de commande défectueux	Défaut du clavier de commande	
E002	Non réception du signal de la télécommande	Défaut du clavier de commande	
E004	Coupure de liaison	Coupure ou débranchement du câble reliant la carte au clavier de commande. Ignorer cette alarme, si elle s'affiche pendant le changement de configuration.	
E101	Allumage raté.	Absence de pellets Qualité du pellet Défaut du système d'allumage Brasero sale	
E105	Allarme sonde de pellets	Sonde de pellets défectueuse ou déconnecté	
E108*	Alarme de sécurité	Porte ou trémie ouverte	
E109	Alarme de pression ou déclenchement du disjoncteur	Système d'évacuation de la fumée sale Usure des joints d'étanchéité Air comburant insuffisant Surchauffe de la trémie de pellets	
E110	Dysfonctionnement sonde de température	Sonde air défectueuse	
E111	Dysfonctionnement sonde fumée	Sonde température fumée défectueuse	
R001	Niveau pellets insuffisant (<i>icône clignotante</i>)	Pellets en cours d'épuisement	
R002	Avertissement entretien programmé (<i>icônes clignotantes</i>)	Le poêle requiert un entretien régulier à effectuer par un personnel spécialisé.	 
R007	Dysfonctionnement capteur de pression (<i>icône clignotante</i>)	Défaut du capteur de pression ou de la carte	
----	Nettoyage du poêle	Chambre de combustion, braséro ou système d'évacuation de la fumée sales. Encrassement ou décrochement des tuyaux de relevé de la pression. Encrassement de l'arrivée de l'air comburant.	
----	Allumage raté	Absence de pellets; Défaut de la résistance d'allumage; Joints usés; Mauvais positionnement du braséro.	

* Uniquement pour les modèles équipés de micro-interrupteurs de sécurité sur la porte ou sur le couvercle du réservoir.

Après avoir vérifié le message, l'alarme peut être effacée en appuyant pendant quelques secondes la touche d'allumage/extinction .

En cas d'affichage du code "E109", réenclencher manuellement le thermostat situé au dos du poêle puis effacer l'alarme (Fig. 6.1) (opération à suivre selon des prescriptions de la Station Technique agréée).



Avant de procéder à un nouveau allumage, vérifier que:

- le poêle est froid
- le braséro est propre et exempt de tout résidu de cendres ou de granulés
- le braséro est correctement positionné dans son siège
- les portes du foyer et le réservoir sont parfaitement fermés



fig. 6.1

ÍNDICE

- 1 CONFIGURACIÓN INICIAL**
 - 1.1 CONEXIÓN A UN CRNOTERMOSTATO EXTERNO
 - 1.2 REGULACIÓN DE LOS DOS VENTILADORES POSTERIORES

- 2 PANEL DE MANDOS**
 - 2.1 DESCRIPCIÓN
 - 2.2 USO DEL PANEL DE MANDO
 - 2.3 PARÁMETROS DE FUNCIONAMIENTO

- 3 OPERACIONES PRELIMINARES**
 - 3.1 CARGA DE LOS PELLETS
 - 3.2 ALIMENTACIÓN ELÉCTRICA
 - 3.3 PROGRAMACIONES INICIALES

- 4 USO DE LA ESTUFA**
 - 4.1 ENCENDIDO
 - 4.2 MODIFICACIÓN DE LOS PARÁMETROS
 - 4.3 APAGADO
 - 4.4 FUNCIONAMIENTO CON TERMOSTATO AMBIENTE
 - 4.5 FUNCIONAMIENTO CON Sonda AMBIENTE A BORDO ESTUFA

- 5 FUNCIONES DISPONIBLES**
 - 5.1 FUNCIÓN TEMPORIZADOR
 - 5.2 FUNCIÓN AHORRO “ECO MODE”
 - 5.3 FUNCIÓN DELTA DE REENCENDIDO
 - 5.4 REENCENDIDO DESPUÉS DEL BLACK-OUT
 - 5.5 FUNCIÓN “BLOQUEO BOTONERA”
 - 5.6 FUNCIÓN ANTICONGELACIÓN

- 6 GESTIÓN DE LAS ALARMAS**

1 CONFIGURACIÓN INICIAL

En función del tipo de instalación es necesario programar la estufa según la configuración más correcta para su funcionamiento.

Antes de proceder es necesario conectar la tensión a la estufa por medio del interruptor de seguridad situado en la parte posterior.

- a) Usando los botones flecha ◀ ▶ ir al menú setup ⚙️ y pulsar el botón ⏪;
- b) Seleccionar la contraseña "7" con el botón + y confirmar con el botón ⏪;
- c) Pasar con los botones + - y seleccionar el submenú [30]; parpadeará "r---";
- d) Presionar el botón ⏪ e introducir el valor "54" usando los botones + -;
- e) Presionar el botón ⏪ para confirmar;
- f) Será utilizada la configuración actualmente en uso;
- g) Si se desea modificar, presionar el botón ⏪ e introducir el valor de la nueva configuración con los botones + -;
- h) Presionar el botón ⏪ para confirmar.

! Después de modificar la configuración podría aparecer un mensaje de error de comunicación por algunos segundos. Ignorarlo y apagar la estufa con el interruptor de seguridad situado en la parte posterior, esperar algunos segundos y volverla a encender.

ES POSIBLE PROGRAMAR DOS CONFIGURACIONES DIFERENTES:

CONFIGURACIÓN 1 (por defecto)

Dicha configuración puede utilizarse para encender y apagar la estufa manualmente o en el modo programado. La estufa modula la potencia en función de la temperatura ambiente leída por la sonda a bordo.

Es posible habilitar la función "Eco-mode" para que la estufa se apague cuando alcanza la temperatura programada y se reencienda cuando la temperatura ambiente desciende por debajo.

En esta configuración es posible habilitar la función anticongelación.

CONFIGURACIÓN 2

Programar dicha configuración cuando la estufa es gestionada desde un termostato (o cronotermostato) externo.

En esta configuración la estufa se apaga cuando el temostato externo alcanza la temperatura fijada.

En esta configuración no es posible habilitar la función anticongelación.

1.1 CONEXIÓN A UN CRONOTERMOSTATO EXTERNO

Se puede conectar a la estufa un cronotermostato externo que encienda y apague la estufa dependiendo de la temperatura programada.

El termostato externo debe conectarse a los bornes 1 y 2 del conector situado en la parte posterior de la estufa y conectado a la sonda externa en fábrica. Desconecte la sonda externa y conecte en su lugar los dos contactos del termostato.

Es importante programar la estufa en la configuración 2 siguiendo las instrucciones del párrafo "Configuración inicial".

! La primera vez, después de la instalación del cronotermostato, la estufa encenderse manualmente mientras el cronotermostato está en el estado "llamada". Esta operación se vuelve necesaria ante la posibilidad que se produzca un corte de alimentación eléctrica o cuando la estufa se apaga manualmente.

! Para evitar la superposición de franjas horarias de funcionamiento, se aconseja desactivar (programar en OFF) el temporizador de la estufa.

1.2 REGULACIÓN DE LOS DOS VENTILADORES POSTERIORES

En el momento de la instalación es posible regular la capacidad de los dos ventiladores posteriores en función del tipo de equipo de distribución realizado (longitud, sección, materiales usados...).

Una vez puesta en funcionamiento la estufa y encendidos los dos ventiladores posteriores desde el menú de la ventilación regule los dos ventiladores posteriores accionando los potenciómetros situados detrás de la estufa (fig.1.1-D) hasta alcanzar el nivel de ventilación deseado.

1.2.1 Conecte los ventiladores posteriores a un termostato externo.

Es posible conectar dos termostatos externos al terminal de conexión de la estufa de forma que los ventiladores posteriores se puedan encender y apagar en función de la temperatura formulada en los termostatos.

Para poder aprovechar esta funcionalidad es necesario que la ventilación de los dos ventiladores posteriores esté formulada en ON.

El termostato que dirige el ventilador izquierdo deberá conectarse a los bornes 3 y 4 del terminal de conexión.

El termostato que dirige el ventilador derecho deberá conectarse a los bornes 5 y 6 del terminal de conexión.

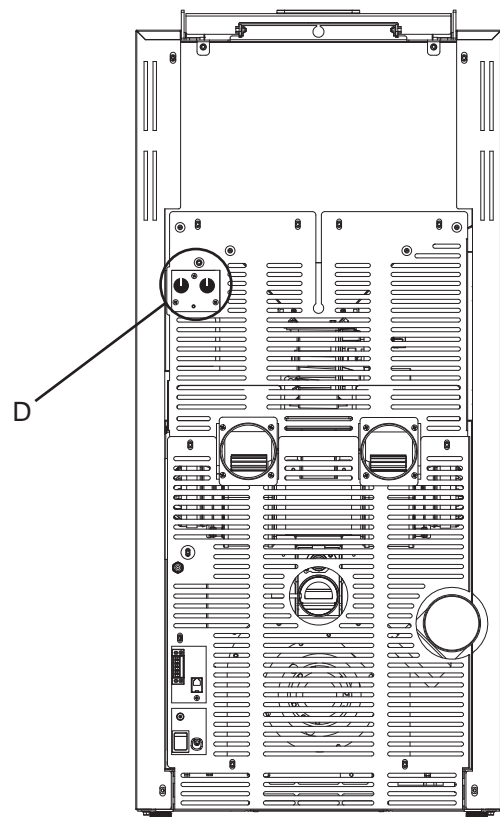

fig. 1.1

2 PANEL DE MANDOS

Antes de leer este manual, consultar la descripción de la estufa en el manual adjunto.

2.1 DESCRIPCIÓN

El panel de mando se compone de:







- A) una parte superior con los led de estado y los iconos con iluminación posterior que identifican cada función;
- B) visor de led;
- C) botón de encendido (⏻);
- D) botón "Anular" y visualización "error" (⏪);
- E) dos botones flecha para desplazarse por las diferentes funciones (⏪ ⏩);
- F) Dos botones (+) y (-) para modificar los parámetros de funcionamiento y entrar a los submenús;
- G) un botón de envío (⏩) para confirmar el parámetro o su selección.









fig. 2.1

 Todos los botones son de tipo capacitivo por lo tanto no necesitan ser presionados para su activación, es suficiente tocar la superficie.

2.1.1 Led de estado

ICONO	AVISO	DESCRIPCIÓN
	Pellet acabándose	Indica que es necesario recargar el depósito de pellet.
	Mantenimiento	Indica que es necesario realizar un mantenimiento
	Asistencia	Indica la presencia de error.
	Receptor del mando a distancia	Recibe los comandos del control remoto (opcional).
	Temporizador activo	Indica si está activa la función temporizador
	Led de señalización estado (cerca del botón (⏻))	Led siempre encendido: estufa encendida y en funcionamiento Led intermitente: Estufa en fase de encendido o en stand-by Led apagado: Estufa apagada









2.1.2 Descripción de los menús

ICONO	FUNCIÓN	DESCRIPCIÓN	VALORES
	Potencia	Programación de la potencia de funcionamiento	1..5
	Ventilación	Regulación de la velocidad del ventilador del aire ambiente.	r: OFF,1..5; A; Hi r: ON/OFF L: ON/OFF
	Temperature	Muestra la temperatura leída en la estancia y permite programar la temperatura deseada.	6°C .. 51°C
	Fuel	Función no utilizada	
	Timer	Habilita o deshabilita el Temporizador. Cuando está habilitado muestra el icono fijo 	ON - OFF

ICONO	FUNCIÓN	SUBMENU	DESCRIPCIÓN	VALORES
	Setup	[1] Temporizador semanal	Asignación de los programas (máx. 3) a los diferentes días de la semana	[d1] ... [d7]
		[2] Programas	Menú de configuración de los programas	[P1] ... [P6]
		[3] Reloj /fecha	Programación reloj y fecha	
		[4] Horas Restantes	Visualiza las horas faltantes aconsejadas para el mantenimiento. Con el valor "Hi" se indica un número de horas superior a 999.	
		[5] Informaciones del sistema	Visualiza la versión software actual	
		[6] Función desactivada		60 ... 80°C
		[7] Función Eco	Habilita o no el Modo Eco que implica el apagado y reencendido automático en función de la temperatura ambiente	OFF; Eco
		[8] Delta de reencendido	Diferencia de grados, con respecto a la temperatura ambiente por debajo de la cual la estufa se vuelve a encender.	0,5 ... 5,0°C
		[9] Temperatura anticongelación	Temperatura mínima por debajo de la cual la estufa se enciende (sólo en la configuración 1)	OFF; 3 ... 20°C
		[10] Bloqueo botonera	Programa el modo de bloqueo de los datos	OFF; Lo; Hi
		[11] Luminosidad del visor	Programa el grado de luminosidad del visor	OFF; 1 ... 5
		[12] Modo visor	Programa el modo de visualización de los datos	OFF; 1 ... 4
		[13] Volumen timbre eléctrico	Programa el volumen del aviso acústico	OFF; 1 ... 5
		[14] Combustión	Puede establecer tres configuraciones diferentes de combustión	1 ... 3
		[15] Función desactivada		
[30] Menú instalador	Modifica/visualiza la configuración de la estufa	PWD: "54"		
[40] Menú de servicio	Menú de competencia del centro de asistencia			

Los submenús [30] y [40] del menú Setup están protegidos con una contraseña y son de uso exclusivo del centro de asistencia técnico.

2.2 USO DEL PANEL DE MANDO

- Usando las flechas   se desplaza entre los diferentes menús que se iluminan cada vez.
- Deteniéndose en una función determinada basta usar el botón  y modificar sus valores con los botones  .
- Otra presión del botón  confirma la modificación.
- En general todos los valores que parpadean en ese momento se pueden modificar con los botones  .
- El botón "anular"  permite anular la modificación; su presión prolongada permite la visualización en el visor de un posible código de alarma o de error.

2.3 PARÁMETROS DE FUNCIONAMIENTO

El funcionamiento de la estufa depende de los parámetros de Potencia, Ventilación y Temperatura programados por el usuario.

2.3.1 MODIFICACIÓN DE LA POTENCIA

La potencia define la cantidad de calor producida por la estufa y por lo tanto incide directamente también en los consumos.

Para modificar la potencia:

- Usando los botones ◀ ▶ ir al menú potencia 🔥 y pulsar el botón ⏪;
- Parpadeará el valor de potencia, modificar el valor con los botones + - (1 mínimo,...,5 máximo).
- Presionar el botón ⏪ para confirmar los datos programados.

2.3.2 Modificación de la ventilación

Para modificar los velocidad de la ventilación:

- Muévase con las teclas ◀ ▶ al menú ventilación 🌿 y pulse la tecla ⏪;
- Use las teclas + - para moverse entre el ventilador central [c], el ventilador derecho [r] y el ventilador izquierdo [l];
- Pulse la tecla ⏪ para seleccionar el ventilador deseado;
- Seleccionando el ventilador central [c]; modifique el valor del mismo con las teclas + - :
 - “OFF” = excluye completamente la ventilación y la estufa sólo funcionara con convección natural;
 - “1” mínimo,...,“5” máximo;
 - “A” = funcionamiento automático (la estufa formulará la velocidad en función de la temperatura ambiente);
 - “Hi” = funcionamiento ultrarrápido (a utilizar sólo si es necesario calentar rápidamente un ambiente);
- Pulse la tecla ⏪ para confirmar los datos formulados.

Si se seleccionan los ventiladores posteriores derecho [r] o izquierdo [l] sólo será posible formular los valores de ON y OFF.

En caso de que el ventilador central se haya puesto en OFF y al menos uno de los dos ventiladores esté en ON el ventilador central se pondrá automáticamente en mínimo.

2.3.3 Modificación de la temperatura ambiente

Modificando dicho valor se define la temperatura que se desea alcanzar en el ambiente, leída directamente por una sonda situada en la estufa.

Para modificar el valor de la temperatura deseada:

- Usando los botones ◀ ▶ ir al menú temperatura 🌡️ y pulsar el botón ⏪;
- Parpadeará el valor actual, modificarlo con los botones + -;
- Presionar el botón ⏪ para confirmar el dato programado.

3 OPERACIONES PRELIMINARES

3.1 CARGA DE LOS PELLETS

La primera operación a realizar antes de encender el producto es llenar el depósito de combustible (pellet).

No cargar directamente de la bolsa para evitar de descargar aserrín u otros elementos extraños que pueden afectar el buen funcionamiento de la estufa y para evitar que se esparzan pellets fuera del depósito.

☞ Asegurarse que se ha cerrado bien la tapa del depósito después que se realiza la operación de carga de pellets.

Un interruptor de seguridad (sólo para los modelos donde esté previsto) comprueba el cierre correcto (IS en la fig. 2.1) y dá una alarma si se deja abierta la tapa del contenedor de pellets por más de un minuto con la estufa en funcionamiento.

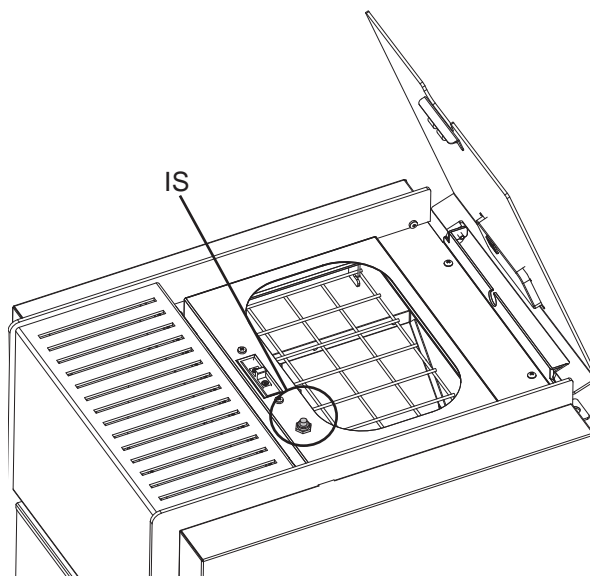

fig. 3.1

3.2 ALIMENTACIÓN ELÉCTRICA

Conectar la estufa a la red eléctrica, usar el interruptor de encendido colocado en la parte posterior de la estufa posicionándolo en "I" (Fig. 2.2). Si la conexión es correcta, la estufa emitirá una serie de señales acústicas intermitentes, y se enciende el visor.

! Para períodos prolongados de desuso, se aconseja posicionar el interruptor posterior de la máquina en la posición OFF (O).

☞ Asegurarse de no tocar el panel de mando cuando se conecta la estufa a la red eléctrica.



fig. 3.2

3.3 PROGRAMACIONES INICIALES

Antes de utilizar la estufa es necesario programar el idioma, la fecha y la hora corriente.

3.3.1 Programación horario

Para modificar la fecha:

- Usando los botones ◀ ▶ ir al menú setup ⚙️ y pulsar el botón ←;
- Seleccionar la contraseña "7" con el botón + y confirmar con el botón ←;
- Pasar con el botón +, seleccionar el submenú [3] y confirmar con el botón ←;
- Parpadeará el valor de la hora, modificar el valor con los botones + - y presionar el botón ▶;
- Parpadeará el valor de los minutos, modificar el valor con los botones + - y presionar el botón ▶;
- Parpadeará el valor del día, modificar el valor con los botones + - y presionar el botón ▶;
- Parpadeará el valor del mes, modificar el valor con los botones + - y presionar el botón ▶;
- Parpadeará el valor del año, modificar el valor con los botones + - y presionar el botón ▶;
- Parpadeará el valor del día corriente de la semana (Lunes = 1... Domingo = 7) modificar el valor con los botones + -;
- Presionar el botón ← para confirmar los datos programados.

3.3.2 Programación luminosidad visor

Se puede programar el grado de atenuación de la luminosidad del visor cuando está en el modo standby.

- Usando los botones ◀ ▶ ir al menú setup ⚙️ y pulsar el botón ⏪;
- Seleccionar la contraseña "7" con el botón + y confirmar con el botón ⏪;
- Pasar con el botón +, seleccionar el submenú [11] y confirmar con el botón ⏪;
- Programar con los botones + y - el valor de luminosidad deseado (OFF, 1 ... 5) y confirmar con el botón ⏪.

3.3.3 Programaciones modo visor

Es posible programar lo que se querrá visualizar en el visor cuando éste esté en el modo standby.

- Usando los botones ◀ ▶ ir al menú setup ⚙️ y pulsar el botón ⏪;
- Seleccionar la contraseña "7" con el botón + y confirmar con el botón ⏪;
- Pasar con el botón +, seleccionar el submenú [12] y confirmar con el botón ⏪;
- Programar con los botones + y - uno de los siguientes valores:
 - "OFF"** • El panel muestra la última visualización efectuada por el usuario;
 - "1"** • Se visualizan de manera cíclica todos los parámetros de funcionamiento;
 - "2"** • Se visualiza la temperatura (leída por la sonda ambiente).
 - "3"** • Se visualiza la hora actual.
 - "4"** • Se visualizan las horas de autonomía que faltan antes de recargar el depósito de alimentación, Si la función "abastecimiento" a sido activada.
- Presionar el botón ⏪ para confirmar los datos programados.

3.3.4 Programación del volumen

Es posible programar el nivel de volumen del timbre eléctrico en función de las propias necesidades:

- Usando los botones ◀ ▶ ir al menú setup ⚙️ y pulsar el botón ⏪;
- Seleccionar la contraseña "7" con el botón + y confirmar con el botón ⏪;
- Pasar con el botón +, seleccionar el submenú [13] y confirmar con el botón ⏪;
- Programar con los botones + y - el nivel de volumen deseado (OFF, 1 ... 5) y confirmar con el botón ⏪.

3.3.5 Optimización de la combustión

Una combustión óptima depende de varios factores (tipo de condiciones de instalación, operación y mantenimiento, tipo de pellet etc ..)

Si al final de la combustión en el brasero son muchos residuos, es aconsejable cambiar las configuraciones de combustión (aumentando el valor) para encontrar la solución más satisfactoria.

- Usando los botones ◀ ▶ ir al menú setup ⚙️ y pulsar el botón ⏪;
- Seleccionar la contraseña "7" con el botón + y confirmar con el botón ⏪;
- Pasar con el botón +, seleccionar el submenú [4] y confirmar con el botón ⏪;
- Seleccionar el submenú "2" y confirmar con el botón + y - uno de los siguientes valores:
 - "1"**
 - "2"**
 - "3"**
- Presionar el botón ⏪ para confirmar los datos programados.

4 USO DE LA ESTUFA

4.1 ENCENDIDO



Antes de cada puesta en marcha, asegúrese de que el brasero esté completamente vacío y colocado correctamente en su asiento.

Para encender la estufa mantener presionado el botón  durante algunos segundos.

El icono en forma de llama comenzará a parpadear, durante la fase de encendido hasta quedar fija con la estufa encendida.



Encendido automático: La estufa está dotada de un dispositivo automático que permite el encendido del pellet sin recurrir al uso de otros encendedores tradicionales.



Evitar encender manualmente la estufa si el sistema de encendido automático está afectado.



En el primer encendido de la estufa, se pueden generar desagradables olores o humos debidos a la evaporación o el desecado de algunos materiales utilizados. Este fenómeno desaparecerá gradualmente.

En los primeros encendidos se aconseja mantener los locales bien aireados.

ESTUFAS DE LA SERIE “ERMETICA”:

Siempre que abra la puerta del hogar evite dejarla abierta durante mucho tiempo para evitar que el sensor de cierre informe del estado de puerta abierta, mediante una alarma sonora.

4.2 MODIFICACIÓN DE LOS PARÁMETROS

Es posible modificar los parámetros de funcionamiento de la estufa según lo indicado.



Los valores programados serán mantenidos hasta la siguiente variación, incluso si la estufa está apagada o desconectada de la alimentación eléctrica.

4.3 APAGADO

Para apagar la estufa tener presionado el botón  durante algunos segundos, el icono con forma de llama se apagará.



Para realizar un nuevo encendido se aconseja esperar que la estufa esté completamente encendida.



Se recomienda apagar la estufa siguiendo escrupulosamente cuanto arriba indicado para evitar hacerlo desconectando la alimentación eléctrica.

4.4 FUNCIONAMIENTO CON TERMOSTATO AMBIENTE

Cuando la estufa es gestionada mediante un termostato (o cronotermostato) externo el instalador debe haber programado la configuración 2. En esta configuración la estufa se apaga cuando el termostato externo alcanza la temperatura programada (circuito abierto).

La estufa se reenciende automáticamente cuando la temperatura desciende por debajo del valor programado en el termostato externo (circuito cerrado).



En el primer encendido, o cuando el apagado se produce directamente desde la estufa (botón ) , se deberá proceder a encender la estufa directamente desde el panel de mando.

4.5 FUNCIONAMIENTO CON Sonda AMBIENTE A BORDO ESTUFA

La estufa puede encenderse/apagarse manualmente o en el modo programado.

La estufa modula la potencia en función de la temperatura ambiente leída por la sonda a bordo (es decir la estufa intenta mantener la temperatura deseada consumiendo lo menos posible).

Ante la posibilidad que el usuario haya habilitado la función “Eco-mode” , en lugar de modular, la estufa se apaga cuando alcanza la temperatura programada y se reenciende cuando la temperatura ambiente desciende por debajo del delta indicado.

Es posible programar la temperatura deseada en el ambiente en el menú temperatura .

5 FUNCIONES DISPONIBLES

5.1 FUNCIÓN TEMPORIZADOR

Con esta función se pueden programar, habilitar y asignar a los diferentes días de la semana, los programas personalizados para el encendido y/o el apagado automático de la estufa.

Es posible programar hasta seis programas personalizados.

Para cada programa se pueden programar: hora de encendido, hora de apagado y temperatura deseada.

A cada día de la semana se le puede asignar hasta tres programas.

Los días de la semana se identifican por los números: Lunes = "d1", Martes = "d2";...; Domingo = "d7".

5.1.1 Configuración programas

- Usando los botones ◀ ▶ ir al menú setup  y pulsar el botón ←;
- Seleccionar la contraseña "7" con el botón + y confirmar con el botón ←;
- Seleccionar el submenú [2] y confirmar con el botón ←;
- Pasar con los botones + - los programas P1...P6; seleccionar con el botón ← lo que se desea modificar;
- Parpadeará el valor de la hora de encendido, modificar el valor con los botones + - y presionar el botón ▶;
- Parpadeará el valor de los minutos, modificar el valor con los botones + - y presionar el botón ▶;
- Parpadeará el valor de la hora de apagado, modificar el valor con los botones + - y presionar el botón ▶;
- Parpadeará el valor de los minutos, modificar el valor con los botones + - y presionar el botón ▶;
- Parpadeará el valor de la temperatura deseada, modificar el valor con los botones + - y presionar el botón ▶;
- Presionar el botón ← para confirmar los datos programados.

5.1.2 Asignar los programas a los días

Con esta función se pueden asignar hasta tres programas diferentes a un solo día.

- Usando los botones ◀ ▶ ir al menú setup  y pulsar el botón ←;
- Seleccionar la contraseña "7" con el botón + y confirmar con el botón ←;
- Seleccionar el submenú [1] y confirmar con el botón ←;
- Elegir con los botones + - el día [d1]...[d7] al cual se desean asociar los programas;
- Seleccionarlo con el botón ←;
- Parpadeará el valor del primer programa a asignar: P1...P6 o bien "OFF" para deshabilitarlo;
- Modificar el valor con los botones + - y presionar el botón ▶;
- Parpadeará el valor del segundo programa a asignar: P1...P6 o bien "OFF" para deshabilitarlo;
- Modificar el valor con los botones + - y presionar el botón ▶;
- Parpadeará el valor del tercer programa a asignar: P1...P6 o bien "OFF" para deshabilitarlo;
- Modificar el valor con los botones + - y presionar el botón ← para confirmar los datos programados.

5.1.3 Habilitación/deshabilitación temporizador

- Usando los botones flecha ◀ ▶ ir al menú Temporizador ;
- Seleccionarlo con el botón ←;
- Pasar con los botones + - y seleccionar: "ON" para habilitar el temporizador o bien "OFF" para deshabilitarlo;
- Presionar el botón ← para confirmar la selección.

Cuando el temporizador está habilitado aparece el icono fijo  para indicar que el temporizador está activo.

5.2 FUNCIÓN AHORRO “ECO MODE”

Habilitando esta función cuando la estufa alcanza la temperatura deseada en el ambiente, se apaga. Si dicha función no es habilitada, la estufa modula su funcionamiento para mantener la temperatura deseada consumiendo lo menos posible. La función “Eco Mode” está disponible sólo en la configuración 1.

Para habilitar/deshabilitar dicha función:

- Usando los botones ir al menú setup y pulsar el botón ;
- Seleccionar la contraseña “7” con el botón y confirmar con el botón ;
- Seleccionar el submenú y confirmar con el botón .
- Programar con los botones no de los siguientes valores:
 - ECO → Activa la función “Eco Mode”
 - OFF → Disactiva la función “Eco Mode”
- Presionar el botón para confirmar los datos programados.

5.3 FUNCIÓN DELTA DE REENCENDIDO

El Delta de reencendido es el número de grados por debajo de la temperatura de apagado superado el cual la estufa se reenciende automáticamente. Por ejemplo, si la estufa se programa para que se apague a 20°C (Modo Eco activo) y se programa un “Delta de reencendido” de 4°C, la estufa se reencenderá cuando registre una temperatura inferior o igual a 16°C.

Para modificar el valor del delta de reencendido:

- Usando los botones ir al menú setup y pulsar el botón ;
- Seleccionar la contraseña “7” con el botón y confirmar con el botón ;
- Seleccionar el submenú y confirmar con el botón ;
- Papadeará el valor; modificarlo con los botones y (0,5 ... 5,0°C);
- Presionar el botón para confirmar el dato programado.

5.4 REENCENDIDO DESPUÉS DEL BLACK-OUT

En caso de interrupción momentánea de corriente eléctrica, la estufa se volverá a encender automáticamente, comprobando las condiciones de seguridad al volver la alimentación.

5.5 FUNCIÓN “BLOQUEO BOTONERA”

Con esta función es posible bloquear el uso del panel de mando para evitar modificaciones accidentales.

Para habilitar/deshabilitar dicha función:

- Usando los botones ir al menú setup y pulsar el botón ;
- Seleccionar la contraseña “7” con el botón y confirmar con el botón ;
- Seleccionar el submenú y confirmar con el botón ;
- Programar con los botones uno de los siguientes valores:
 - “OFF” Bloqueo botonera desactivado
 - “Lo” Queda habilitado sólo el botón de encendido/apagado
 - “Hi” Bloqueo botonera activado
- Presionar el botón para confirmar los datos programados.

5.6 FUNCIÓN ANTICONGELACIÓN



(sólo en la configuración 1)

Es posible programar una temperatura mínima por debajo de la cual la estufa se enciende (fuera de las franjas horarias programadas). Para modificar el valor de la temperatura “anticongelación”:















- Usando los botones ir al menú setup y pulsar el botón ;
- Seleccionar la contraseña “7” con el botón y confirmar con el botón ;
- Seleccionar el submenú y confirmar con el botón .
- Papadeará el valor, modificarlo con los botones (OFF; 3...20°C);
- Presionar el botón para confirmar el dato programado.

6 GESTIÓN DE LAS ALARMAS

Si se produce una anomalía en el funcionamiento, se activa el siguiente procedimiento:

- 1) Alarma acústica (beep);
- 2) Se ilumina uno de los siguientes led de sistema:   ;
- 3) Si la anomalía se refiere a un error, la estufa se apagará.

La presión prolongada del botón “anular”  permite la visualización en el visor del código de error:

CÓDIGO ERROR/AVISO	DESCRIPCIÓN	POSIBLES CAUSAS	LED
E001	Panel de mando defectuoso	Defecto del panel de mando	
E002	Error de comunicación señal de mando a distancia	Defecto del panel de mando	
E004	Error de comunicación	Cable de conexión entre la tarjeta y el panel de mando interrumpido o desconectado. Si aparece durante el cambio de configuración, ignorar dicho error.	
E101	Error de no encendido	Faltan pellets Calidad del pellet Sistema de encendido averiado Brasero sucio	
E105	Malfuncionamiento sonda pellet	Sonda pellet defectuosa o desconectada	
E108*	Error de seguridad	Puerta o portezuela de carga abiertas	
E109	Error de presión o dispositivo de seguridad térmica	Sistema de evacuación humos sucio Guarniciones de estanqueidad gastadas Aire comburente insuficiente Problemas de sobrecalentamiento del depósito pellet	
E110	Malfuncionamiento sonda de temperatura	Sonda aire defectuosa	
E111	Malfuncionamiento sonda humos	Sonda temperatura humos defectuosa	
R001	Nivel pellet bajo (<i>icono intermitente</i>)	Pellet acabándose	
R002	Aviso de mantenimiento programado (<i>iconos intermitentes</i>)	Periódicamente la estufa indica que se debe realizar un mantenimiento por parte de un técnico especializado	 
R007	Malfuncionamiento sensor de presión. (<i>iconos intermitentes</i>)	Sensor de presión o tarjeta averías	
----	Limpieza estufa	Cámara de combustión, brasero o sistema de evacuación de humos. Tubos registro de presión separados u obstruidos. Entrada del aire comburente obstruida.	
----	Error de no encendido	Pellet agotados, Resistencia de encendido averiada, Guarniciones gastadas, Posición del brasero incorrecta	

* Sólo para los modelos equipados con microinterruptores de seguridad en la puerta o la tapa del contenedor de pellets.

Después de comprobar el tipo de mensaje es posible reajustar la alarma presionando algunos instantes el botón de encendido/apagado .

Ante la eventualidad que el código error sea “E109”, antes de reajustar la alarma, reactivar el termostato de rearme manual situado en la parte posterior de la estufa (Fig. 5.1) (Responsabilidad del Centro de Asistencia Técnica).



Antes de proceder a un nuevo encendido, compruebe que:

- la estufa se haya enfriado
- el brasero esté limpio y libre de cualquier residuo de ceniza o de pellets
- el brasero está colocado correctamente en su asiento
- las puertas de la chimenea y el tanque están perfectamente cerrados



fig. 6.1

PALAZZETTI

IL CALORE CHE PIACE ALLA NATURA

Palazzetti Lelio s.p.a.

Via Roveredo, 103
cap 33080 - Porcia (PN) - ITALY
Internet: www.palazzetti.it

Per conoscere il centro di assistenza tecnica
(CAT) più vicino a te consulta il sito

www.palazzetti.it

oppure chiama il numero



La Ditta Palazzetti non si assume alcuna responsabilità per eventuali errori del presente opuscolo e si ritiene libera di variare senza preavviso le caratteristiche dei propri prodotti.

Palazzetti accepts no liability for any mistakes in this handbook and is free to modify the features of its products without prior notice.

Die Firma Palazzetti übernimmt für eventuelle Fehler in diesem Heft keine Verantwortung und behält sich das Recht vor, die Eigenschaften ihrer Produkte ohne Vorbescheid zu ändern.

Palazzetti décline toute responsabilité en cas d'erreurs dans la présente documentation et conserve la faculté de modifier sans préavis les caractéristiques de l'appareil.

La empresa Palazzetti no se responsabiliza de los errores eventuales de este manual y tiene el derecho de modificar sin previo aviso las características de sus productos.